

# HOHAGE

---

Wir biegen Lösungen



# HOHAGE

---

Wir biegen Lösungen

1

## **Einfach- und Doppelhaken**

Single and double hooks  
Ganchos simples y dobles  
Broches simples et doubles

## Lochwandhaken verzinkt

Single hook zinc

Gancho simple zincado

Crochet simple zingué

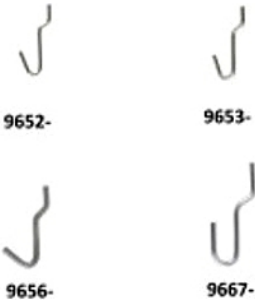

15 / 25			mm	mm		kg
9652-020035A			2,0	35	100	0,1
9653-025035A			2,5	35	100	0,3
9656-034040A			3,4	40	100	0,4
9667-034050A			3,4	50	100	0,6

## Lochhaken verzinkt

Ceiling anchor hook zinc

Gancho techo zincado

Crochet accrochage à plafond zingué

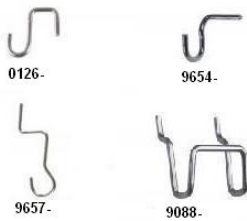

15 / 25			mm	mm		kg
9657-020045A			2,0	45	100	0,2
9654-025024A			2,5	24	100	0,3
0126-030025A			3,0	25	100	0,4
9088-025030A			2,5	30	100	0,6

## Schlaufenhaken ca. 10 Grad Vorsteigung, verzinkt

Double loop hook gradient approx. 10 degrees, zinc

Gancho doble para fondo perforado angulo aprox. 10 grados, zincado

Broche double en forme de boucle pente environ 10 degrés, zingué



15 / 25	mm		mm	mm		kg
9688-025040A	25/30		2,5	40	50	0,6
9688-025060A	25/30		2,5	60	25	0,4
9688-025080A	25/30		2,5	80	25	1,0
9688-025100A	25/30		2,5	100	25	1,2

## Schlaufenhaken ca. 10 Grad Vorsteigung, verzinkt

Double loop hook gradient approx. 10 degrees, zinc

Gancho doble para fondo perforado angulo aprox. 10 grados, zincado

Broche double en forme de boucle pente environ 10 degrés, zingué



15 / 25	mm		mm	mm		kg
9688-030100A	25/30		3,0	100	25	1,7
9688-030120A	25/30		3,0	120	25	1,9
9688-030140A	25/30		3,0	140	50	2,1
9688-030160A	25/30		3,0	160	50	2,3
9688-030180A	25/30		3,0	180	50	2,5
9688-030200A	25/30		3,0	200	50	2,7

## Schlaufenhaken ca. 10 Grad Vorsteigung, verzinkt

**Double loop hook** gradient approx. 10 degrees, zinc

**Gancho doble fondo perforado** angulo aprox. 10 grados, zincado

**Broche double en forme de boucle** pente environ 10 degrés, zinguée

15°/25°	mm	mm	mm	mm	mm	kg	
9688-034100A	25/30			3,4	100	25	2,5
9688-034120A	25/30			3,4	120	25	2,7
9688-034140A	25/30			3,4	140	50	2,5
9688-034160A	25/30			3,4	160	50	3,1
9688-034200A	25/30			3,4	200	50	3,5



## Schlaufenhaken ca. 10 Grad Vorsteigung, verzinkt

**Double loop hook** gradient approx. 10 degrees, zinc

**Gancho doble para fondo perforado** angulo aprox. 10 grados, zincado

**Broche double en forme de boucle** pente environ 10 degrés, zinguée

15°/25°	mm	mm	mm	mm	mm	kg	
9688-038200A	25/30			3,8	200	50	4,5
9688-038250A	25/30			3,8	250	50	5,4
9688-038275A	25/30			3,8	275	50	5,9
9688-038300A	25/30			3,8	300	50	6,3



## Schlaufenhaken ca. 15 Grad Vorsteigung, verzinkt

**Double loop hook** gradient approx. 15 degrees, zinc

**Gancho doble para fondo perforado** angulo aprox. 15 grados, zincado

**Broche double en forme de boucle** pente environ 15 degrés, zinguée

15°/25°	mm	mm	mm	mm	mm	kg	
9689-038200A	25/30			3,8	200	50	4,5
9689-038275A	25/30			3,8	275	50	5,8
9689-038340A	25/30			3,8	340	50	6,9
9689-038370A	25/30			3,8	370	50	7,3



## Schlaufenhaken ca. 15 Grad Vorsteigung, verzinkt

**Double loop hook** gradient approx. 15 degrees, zinc

**Gancho doble para fondo perforado** angulo aprox. 15 grados, zincado

**Broche double en forme de boucle** pente environ 15 degrés, zinguée

15°/25°	mm	mm	mm	mm	mm	kg	
9689-040300A	25/30			4,0	300	50	6,4
9689-040340A	25/30			4,0	340	50	7,3
9689-040370A	25/30			4,0	370	50	8,2
9689-040400A	25/30			4,0	400	50	9,1



## Einfachhaken verzinkt

Single hook zinc

Gancho simple zincado

Crochet simple zingué



15		mm (mm)	mm	mm		kg
9781-034060A		15(3,4)	3,4	60	50	1,2
9781-034080A		15(3,4)	3,4	80	50	1,3
9781-034100A		15(3,4)	3,4	100	50	1,4
9781-034120A		15(3,4)	3,4	120	50	1,6
9781-034160A		15(3,4)	3,4	160	50	1,8
9781-034200A		15(3,4)	3,4	200	50	2,1

## Einfachhaken verzinkt

Single hook zinc

Gancho simple zincado

Crochet simple zingué



15		mm (mm)	mm	mm		kg
9781-048120A		15(3,4)	4,8	120	50	2,7
9781-048160A		15(3,4)	4,8	160	50	3,7
9781-048200A		15(3,4)	4,8	200	50	4,7

## Einfachhaken mit Kugel verzinkt

Single hook with ball tip end zinc

Gancho simple con terminal bola zincado

Crochet simple à bille zingué



15	25	mm (mm)	mm	mm		kg
9773-034045A	9673-034045A	30/25(2,5)	3,4	45	50	0,9
9773-034060A	9673-034060A	30/25(2,5)	3,4	60	50	1,1
9773-034080A	9673-034080A	30/25(2,5)	3,4	80	50	1,3
9773-034100A	9673-034100A	30/25(2,5)	3,4	100	50	1,5
9773-034120A	9673-034120A	30/25(2,5)	3,4	120	50	1,7
9773-034140A	9673-034140A	30/25(2,5)	3,4	140	50	1,9
9773-034160A	9673-034160A	30/25(2,5)	3,4	160	50	2,1
9773-034180A	9673-034180A	30/25(2,5)	3,4	180	50	2,3
9773-034200A	9673-034200A	30/25(2,5)	3,4	200	50	2,5
9773-034220A	9673-034220A	30/25(2,5)	3,4	220	50	2,7

## Einfachhaken mit Kugel verzinkt

Single hook with ball tip end zinc

Gancho simple con terminal bola zincado





Crochet simple à bille zingué



15	25	mm (mm)	mm	mm		kg
9778-034060A	9678-034060A	30/25(3,4)	3,4	60	50	1,2
9778-034080A	9678-034080A	30/25(3,4)	3,4	80	50	1,4
9778-034100A	9678-034100A	30/25(3,4)	3,4	100	50	1,6
9778-034120A	9678-034120A	30/25(3,4)	3,4	120	50	1,8
9778-034140A	9678-034140A	30/25(3,4)	3,4	140	50	2,0
9778-034160A	9678-034160A	30/25(3,4)	3,4	160	50	2,2
9778-034180A	9678-034180A	30/25(3,4)	3,4	180	50	2,4
9778-034200A	9678-034200A	30/25(3,4)	3,4	200	50	2,6
9778-034220A	9678-034220A	30/25(3,4)	3,4	220	50	2,8

## Einfachhaken mit Kugel verzinkt





Single hook with ball tip end zinc  
Gancho simple con terminal bola zincado  
Crochet simple à bille zingué

15	25					
9786-040060A	9686-040060A	30/25(3,4)	4,0	60	50	1,5
9786-040080A	9686-040080A	30/25(3,4)	4,0	80	50	1,7
9786-040100A	9686-040100A	30/25(3,4)	4,0	100	50	1,9
9786-040120A	9686-040120A	30/25(3,4)	4,0	120	50	2,1
9786-040140A	9686-040140A	30/25(3,4)	4,0	140	50	2,3
9786-040160A	9686-040160A	30/25(3,4)	4,0	160	50	2,5
9786-040180A	9686-040180A	30/25(3,4)	4,0	180	50	2,7
9786-040200A	9686-040200A	30/25(3,4)	4,0	200	50	2,9
9786-040220A	9686-040220A	30/25(3,4)	4,0	220	50	3,1



## Einfachhaken verzinkt





Single hook zinc  
Gancho simple zincado  
Crochet simple zingué

15	25					
9340-048150A	9240-048150A	30/25(3,4)	4,8	150	50	3,2
9340-048200A	9240-048200A	30/25(3,4)	4,8	200	50	4,0
9340-048250A	9240-048250A	30/25(3,4)	4,8	250	50	4,7
9340-048300A	9240-048300A	30/25(3,4)	4,8	300	50	5,4
9340-048400A	9240-048400A	30/25(3,4)	4,8	400	50	6,8



## Einfachhaken verzinkt





Single hook zinc  
Gancho simple zincado  
Crochet simple zingué

15	25					
9787-060100A	9687-060100A	45/50(3,8)	6,0	100	50	4,4
9787-060150A	9687-060150A	45/50(3,8)	6,0	150	50	5,5
9787-060200A	9687-060200A	45/50(3,8)	6,0	200	50	6,5
9787-060250A	9687-060250A	45/50(3,8)	6,0	250	50	7,5
9787-060300A	9687-060300A	45/50(3,8)	6,0	300	50	8,5
9787-060350A	9687-060350A	45/50(3,8)	6,0	350	50	9,5
9787-060400A	9687-060400A	45/50(3,8)	6,0	400	50	10,5
9787-060450A	9687-060450A	45/50(3,8)	6,0	450	50	11,5



## Einfachhaken verzinkt

Single hook zinc  
Gancho simple zincado  
Crochet simple zingué







15	25					
9790-080200A	9690-080200A	45/50(3,8)	8,0	200	50	11,8
9790-080300A	9690-080300A	45/50(3,8)	8,0	300	50	14,6
9790-080400A	9690-080400A	45/50(3,8)	8,0	400	50	18,7
9790-080500A	9690-080500A	45/50(3,8)	8,0	500	50	24,8
9791-100300A	9691-100300A	45/50(3,8)	10,0	300	50	22,5
9791-100400A	9691-100400A	45/50(3,8)	10,0	400	50	30,7
9791-100500A	9691-100500A	45/50(3,8)	10,0	500	50	36,2

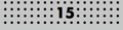
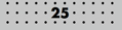

## Doppelhaken verzinkt

**Double hook** zinc  
**Gancho doble** zincado  
**Crochet double** zingué







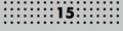
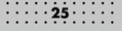

							
9794-034100A	9694-034100A	45/50(2,5)		3,4	100	50	2,5
9794-034150A	9694-034150A	45/50(2,5)		3,4	150	50	3,2
9794-034200A	9694-034200A	45/50(2,5)		3,4	200	50	3,9

## Doppelhaken verzinkt

**Double hook** zinc  
**Gancho doble** zincado  
**Crochet double** zingué







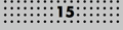
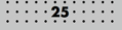

							
9122-034100A	9022-034100A	45/50(3,8)		3,4	100	50	3,0
9122-034150A	9022-034150A	45/50(3,8)		3,4	150	50	3,7
9122-034200A	9022-034200A	45/50(3,8)		3,4	200	50	4,4

## Doppelhaken verzinkt

**Double hook** zinc  
**Gancho doble** zincado  
**Crochet double** zingué







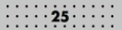

							
9307-040150A	9207-040150A	45/50(3,8)		4,0	150	50	4,8
9307-040200A	9207-040200A	45/50(3,8)		4,0	200	50	5,7
9307-040250A	9207-040250A	45/50(3,8)		4,0	250	50	6,6
9307-040300A	9207-040300A	45/50(3,8)		4,0	300	50	7,5

## Doppelhaken verzinkt





**Double hook** zinc  
**Gancho doble** zincado  
**Crochet double** zingué



							
9304-048200A	9204-048200A	45/50(3,8)		4,8	200	50	7,8
9304-048250A	9204-048250A	45/50(3,8)		4,8	250	50	9,4
9304-048300A	9204-048300A	45/50(3,8)		4,8	300	50	10,0
9304-048400A	9204-048400A	45/50(3,8)		4,8	400	50	12,2

## Doppelhaken verzinkt

Double hook zinc  
Gancho doble zincado  
Crochet double zingué





15	25					
9306-060200A	9206-060200A	45/50(3,8)	6,0	200	50	11,8
9306-060300A	9206-060300A	45/50(3,8)	6,0	300	50	16,3
9306-060400A	9206-060400A	45/50(3,8)	6,0	400	50	20,8

Mindestbestellmenge 1000 Stück je Sorte / minimum order quantity 1000 pieces  
Quantité minimale de commande: 1000 pièces / cantidad mínima por pedido: 1000 unidades



## Schwerlasthaken verzinkt

Triple hook heavy type zinc  
Gancho triple cargas pesadas zincado  
Crochet triple zingué





15	25					
2491582010	2490582010	45/50(3,8)	3,8/6,0	200	50	16,2
2491583010	2490583010	45/50(3,8)	3,8/6,0	300	50	17,3
2491584010	2490584010	45/50(3,8)	3,8/6,0	400	50	23,1
2491585010	2490585010	45/50(3,8)	3,8/6,0	500	50	29,0

Artikel nur auf Anfrage erhältlich / only on request / uniquement sur demande / solamente a pedido



## Schwerlasthaken verzinkt

Triple hook heavy type zinc  
Gancho triple cargas pesadas zincado  
Crochet triple zingué

15	25					
2491593010	2490593010	45/50(3,8)	3,8/8,0	300	50	18,3
2491594010	2490594010	45/50(3,8)	3,8/8,0	400	50	24,1
2491595010	2490595010	45/50(3,8)	3,8/8,0	500	50	30,0

Artikel nur auf Anfrage erhältlich / only on request / uniquement sur demande / solamente a pedido











## Einfachhaken für Lochwand Kunststoff

Single hook for pegboard plastics

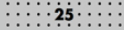
Gancho simple para fondo perforado plástico

Crochet simple pour fond perforé plastique



						
8125390525	25	5,0	50	RAL9005	50	0,5
8125391025	25	5,0	100	RAL9005	50	0,7
8125391525	25	5,0	150	RAL9005	50	0,9
8125392025	25	5,0	200	RAL9005	50	1,1
8125390515	25	5,0	50	RAL9001	50	0,5
8125391015	25	5,0	100	RAL9001	50	0,7
8125391515	25	5,0	150	RAL9001	50	0,9
8125392015	25	5,0	200	RAL9001	50	1,1

Artikel nur auf Anfrage erhältlich / only on request / uniquement sur demande / solamente a pedido







## Einfachhaken für Papprückwand Kunststoff

Single hook for cardboard displays plastics

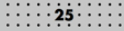
Gancho simple para expositor de carton plástico

Crochet simple pour display carton plastique



						
8124390525	25	5,0	50	RAL9005	50	0,5
8124391025	25	5,0	100	RAL9005	50	0,7
8124391525	25	5,0	150	RAL9005	50	0,9
8124392025	25	5,0	200	RAL9005	50	1,1
8124390515	25	5,0	50	RAL9001	50	0,5
8124391015	25	5,0	100	RAL9001	50	0,7
8124391515	25	5,0	150	RAL9001	50	0,9
8124392015	25	5,0	200	RAL9001	50	1,1

Artikel nur auf Anfrage erhältlich / only on request / uniquement sur demande / solamente a pedido







## Einfachhaken mit Klemmvorrichtung Kunststoff

Universal single hook with clip device plastics

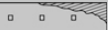
Gancho simple universal con dispositivo de clip plástico

Crochet simple avec dispositif de blocage plastique



						
8123390525	20	5,0	50	RAL9005	50	0,4
8123391025	20	5,0	100	RAL9005	50	0,5
8123391525	20	5,0	150	RAL9005	50	0,6
8123390515	20	5,0	50	RAL9001	50	0,4
8123391015	20	5,0	100	RAL9001	50	0,5
8123391515	20	5,0	150	RAL9001	50	0,6

Artikel nur auf Anfrage erhältlich / only on request / uniquement sur demande / solamente a pedido







## Einfachhaken für Lamellenwand Kunststoff

Single hook for slatwall plastics

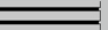
Gancho simple para lamas plástico

Crochet simple pour fond lame plastique









						
8122390525	25	5,0	50	RAL9005	50	0,7
8122391025	25	5,0	100	RAL9005	50	0,8
8122391525	25	5,0	150	RAL9005	50	1,1
8122392025	25	5,0	200	RAL9005	50	1,2
8122392525	25	5,0	250	RAL9005	50	1,3
8122390515	25	5,0	50	RAL9001	50	0,7
8122391015	25	5,0	100	RAL9001	50	0,8
8122391515	25	5,0	150	RAL9001	50	1,1
8122392015	25	5,0	200	RAL9001	50	1,2
8122392515	25	5,0	250	RAL9001	50	1,3

Artikel nur auf Anfrage erhältlich / only on request / uniquement sur demande / solamente a pedido

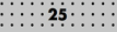
## Wir biegen Lösungen

### Doppelhaken für Lochwand Kunststoff

Double hook for pegboard plastics  
Gancho doble para fondo perforado plástico  
Crochet double pour fond perforé plastique







 25	 mm	 mm	 mm			 kg
8125400525	25	5,0	50	RAL9005	50	0,7
8125401025	25	5,0	100	RAL9005	50	1,0
8125401525	25	5,0	150	RAL9005	50	1,3
8125402025	25	5,0	200	RAL9005	50	1,6
8125400515	25	5,0	50	RAL9001	50	0,7
8125401015	25	5,0	100	RAL9001	50	1,0
8125401515	25	5,0	150	RAL9001	50	1,3
8125402015	25	5,0	200	RAL9001	50	1,6

Artikel nur auf Anfrage erhältlich / only on request / uniquement sur demande / solamente a pedido



### Doppelhaken für Papprückwand Kunststoff







Double hook for cardboard displays plastics  
Gancho doble para expositor de carton plástico  
Crochet double pour display carton plastique

 25	 mm	 mm	 mm			 kg
8124400525	25	5,0	50	RAL9005	50	0,7
8124401025	25	5,0	100	RAL9005	50	1,0
8124401525	25	5,0	150	RAL9005	50	1,3
8124402025	25	5,0	200	RAL9005	50	1,6
8124400515	25	5,0	50	RAL9001	50	0,7
8124401015	25	5,0	100	RAL9001	50	1,0
8124401515	25	5,0	150	RAL9001	50	1,3
8124402015	25	5,0	200	RAL9001	50	1,6

Artikel nur auf Anfrage erhältlich / only on request / uniquement sur demande / solamente a pedido









### Blisterhaken mit Klemmvorrichtung Kunststoff

	 mm	 mm	 mm			 kg
8123410525	20	5,0	50	RAL9005	50	0,6
8123411025	20	5,0	100	RAL9005	50	0,7
8123411525	20	5,0	150	RAL9005	50	0,8
8123410515	20	5,0	50	RAL9001	50	0,6
8123411015	20	5,0	100	RAL9001	50	0,7
8123411515	20	5,0	150	RAL9001	50	0,8

Artikel nur auf Anfrage erhältlich / only on request / uniquement sur demande / solamente a pedido



### Doppelhaken für Lamellenwand Kunststoff

	 mm	 mm	 mm			 kg
8122400525	30	5,0	50	RAL9005	50	0,8
8122401025	30	5,0	100	RAL9005	50	1,1
8122401525	30	5,0	150	RAL9005	50	1,4
8122402025	30	5,0	200	RAL9005	50	1,7
8122402525	30	5,0	250	RAL9005	50	2,0
8122400515	30	5,0	50	RAL9001	50	0,8
8122401015	30	5,0	100	RAL9001	50	1,1
8122401515	30	5,0	150	RAL9001	50	1,4
8122402015	30	5,0	200	RAL9001	50	1,7
8122402515	30	5,0	250	RAL9001	50	2,0

Artikel nur auf Anfrage erhältlich / only on request / uniquement sur demande / solamente a pedido



# HOHAGE

---

Wir biegen Lösungen

1

## **Einfach- und Doppelhaken**

Single and double hooks  
Ganchos simples y dobles  
Broches simples et doubles

## Lochwandhaken verzinkt

Single hook zinc

Gancho simple zincado

Crochet simple zingué

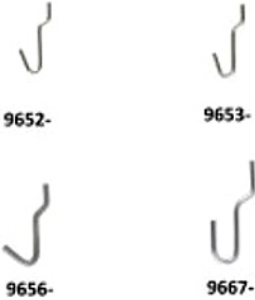

15 / 25			mm	mm		kg
9652-020035A			2,0	35	100	0,1
9653-025035A			2,5	35	100	0,3
9656-034040A			3,4	40	100	0,4
9667-034050A			3,4	50	100	0,6

## Lochhaken verzinkt

Ceiling anchor hook zinc

Gancho techo zincado

Crochet accrochage à plafond zingué

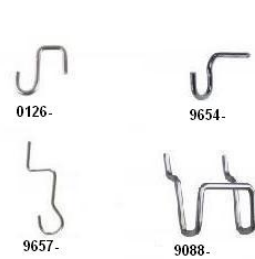

15 / 25			mm	mm		kg
9657-020045A			2,0	45	100	0,2
9654-025024A			2,5	24	100	0,3
0126-030025A			3,0	25	100	0,4
9088-025030A			2,5	30	100	0,6

## Schlaufenhaken ca. 10 Grad Vorsteigung, verzinkt

Double loop hook gradient approx. 10 degrees, zinc

Gancho doble para fondo perforado angulo aprox. 10 grados, zincado

Broche double en forme de boucle pente environ 10 degrés, zingué



15 / 25	mm		mm	mm		kg
9688-025040A	25/30		2,5	40	50	0,6
9688-025060A	25/30		2,5	60	25	0,4
9688-025080A	25/30		2,5	80	25	1,0
9688-025100A	25/30		2,5	100	25	1,2

## Schlaufenhaken ca. 10 Grad Vorsteigung, verzinkt

Double loop hook gradient approx. 10 degrees, zinc

Gancho doble para fondo perforado angulo aprox. 10 grados, zincado

Broche double en forme de boucle pente environ 10 degrés, zingué



15 / 25	mm		mm	mm		kg
9688-030100A	25/30		3,0	100	25	1,7
9688-030120A	25/30		3,0	120	25	1,9
9688-030140A	25/30		3,0	140	50	2,1
9688-030160A	25/30		3,0	160	50	2,3
9688-030180A	25/30		3,0	180	50	2,5
9688-030200A	25/30		3,0	200	50	2,7

## Schlaufenhaken ca. 10 Grad Vorsteigung, verzinkt

**Double loop hook** gradient approx. 10 degrees, zinc

**Gancho doble fondo perforado** angulo aprox. 10 grados, zincado

**Broche double en forme de boucle** pente environ 10 degrés, zinguée

15°/25°	mm	mm	mm	mm	mm	kg	
9688-034100A	25/30			3,4	100	25	2,5
9688-034120A	25/30			3,4	120	25	2,7
9688-034140A	25/30			3,4	140	50	2,5
9688-034160A	25/30			3,4	160	50	3,1
9688-034200A	25/30			3,4	200	50	3,5



## Schlaufenhaken ca. 10 Grad Vorsteigung, verzinkt

**Double loop hook** gradient approx. 10 degrees, zinc

**Gancho doble para fondo perforado** angulo aprox. 10 grados, zincado

**Broche double en forme de boucle** pente environ 10 degrés, zinguée

15°/25°	mm	mm	mm	mm	mm	kg	
9688-038200A	25/30			3,8	200	50	4,5
9688-038250A	25/30			3,8	250	50	5,4
9688-038275A	25/30			3,8	275	50	5,9
9688-038300A	25/30			3,8	300	50	6,3



## Schlaufenhaken ca. 15 Grad Vorsteigung, verzinkt

**Double loop hook** gradient approx. 15 degrees, zinc

**Gancho doble para fondo perforado** angulo aprox. 15 grados, zincado

**Broche double en forme de boucle** pente environ 15 degrés, zinguée

15°/25°	mm	mm	mm	mm	mm	kg	
9689-038200A	25/30			3,8	200	50	4,5
9689-038275A	25/30			3,8	275	50	5,8
9689-038340A	25/30			3,8	340	50	6,9
9689-038370A	25/30			3,8	370	50	7,3



## Schlaufenhaken ca. 15 Grad Vorsteigung, verzinkt

**Double loop hook** gradient approx. 15 degrees, zinc

**Gancho doble para fondo perforado** angulo aprox. 15 grados, zincado

**Broche double en forme de boucle** pente environ 15 degrés, zinguée

15°/25°	mm	mm	mm	mm	mm	kg	
9689-040300A	25/30			4,0	300	50	6,4
9689-040340A	25/30			4,0	340	50	7,3
9689-040370A	25/30			4,0	370	50	8,2
9689-040400A	25/30			4,0	400	50	9,1



## Einfachhaken verzinkt

Single hook zinc  
Gancho simple zincado  
Crochet simple zingué



15		mm (mm)	mm	mm		kg
9781-034060A		15(3,4)	3,4	60	50	1,2
9781-034080A		15(3,4)	3,4	80	50	1,3
9781-034100A		15(3,4)	3,4	100	50	1,4
9781-034120A		15(3,4)	3,4	120	50	1,6
9781-034160A		15(3,4)	3,4	160	50	1,8
9781-034200A		15(3,4)	3,4	200	50	2,1

## Einfachhaken verzinkt

Single hook zinc  
Gancho simple zincado  
Crochet simple zingué



15		mm (mm)	mm	mm		kg
9781-048120A		15(3,4)	4,8	120	50	2,7
9781-048160A		15(3,4)	4,8	160	50	3,7
9781-048200A		15(3,4)	4,8	200	50	4,7

## Einfachhaken mit Kugel verzinkt

Single hook with ball tip end zinc  
Gancho simple con terminal bola zincado  
Crochet simple à bille zingué



15	25	mm (mm)	mm	mm		kg
9773-034045A	9673-034045A	30/25(2,5)	3,4	45	50	0,9
9773-034060A	9673-034060A	30/25(2,5)	3,4	60	50	1,1
9773-034080A	9673-034080A	30/25(2,5)	3,4	80	50	1,3
9773-034100A	9673-034100A	30/25(2,5)	3,4	100	50	1,5
9773-034120A	9673-034120A	30/25(2,5)	3,4	120	50	1,7
9773-034140A	9673-034140A	30/25(2,5)	3,4	140	50	1,9
9773-034160A	9673-034160A	30/25(2,5)	3,4	160	50	2,1
9773-034180A	9673-034180A	30/25(2,5)	3,4	180	50	2,3
9773-034200A	9673-034200A	30/25(2,5)	3,4	200	50	2,5
9773-034220A	9673-034220A	30/25(2,5)	3,4	220	50	2,7

## Einfachhaken mit Kugel verzinkt





Single hook with ball tip end zinc  
Gancho simple con terminal bola zincado  
Crochet simple à bille zingué



15	25	mm (mm)	mm	mm		kg
9778-034060A	9678-034060A	30/25(3,4)	3,4	60	50	1,2
9778-034080A	9678-034080A	30/25(3,4)	3,4	80	50	1,4
9778-034100A	9678-034100A	30/25(3,4)	3,4	100	50	1,6
9778-034120A	9678-034120A	30/25(3,4)	3,4	120	50	1,8
9778-034140A	9678-034140A	30/25(3,4)	3,4	140	50	2,0
9778-034160A	9678-034160A	30/25(3,4)	3,4	160	50	2,2
9778-034180A	9678-034180A	30/25(3,4)	3,4	180	50	2,4
9778-034200A	9678-034200A	30/25(3,4)	3,4	200	50	2,6
9778-034220A	9678-034220A	30/25(3,4)	3,4	220	50	2,8

## Einfachhaken mit Kugel verzinkt





Single hook with ball tip end zinc  
Gancho simple con terminal bola zincado  
Crochet simple à bille zingué

15	25				
9786-040060A	9686-040060A	30/25(3,4)	4,0	60	1,5
9786-040080A	9686-040080A	30/25(3,4)	4,0	80	1,7
9786-040100A	9686-040100A	30/25(3,4)	4,0	100	1,9
9786-040120A	9686-040120A	30/25(3,4)	4,0	120	2,1
9786-040140A	9686-040140A	30/25(3,4)	4,0	140	2,3
9786-040160A	9686-040160A	30/25(3,4)	4,0	160	2,5
9786-040180A	9686-040180A	30/25(3,4)	4,0	180	2,7
9786-040200A	9686-040200A	30/25(3,4)	4,0	200	2,9
9786-040220A	9686-040220A	30/25(3,4)	4,0	220	3,1



## Einfachhaken verzinkt





Single hook zinc  
Gancho simple zincado  
Crochet simple zingué

15	25				
9340-048150A	9240-048150A	30/25(3,4)	4,8	150	3,2
9340-048200A	9240-048200A	30/25(3,4)	4,8	200	4,0
9340-048250A	9240-048250A	30/25(3,4)	4,8	250	4,7
9340-048300A	9240-048300A	30/25(3,4)	4,8	300	5,4
9340-048400A	9240-048400A	30/25(3,4)	4,8	400	6,8



## Einfachhaken verzinkt





Single hook zinc  
Gancho simple zincado  
Crochet simple zingué

15	25				
9787-060100A	9687-060100A	45/50(3,8)	6,0	100	4,4
9787-060150A	9687-060150A	45/50(3,8)	6,0	150	5,5
9787-060200A	9687-060200A	45/50(3,8)	6,0	200	6,5
9787-060250A	9687-060250A	45/50(3,8)	6,0	250	7,5
9787-060300A	9687-060300A	45/50(3,8)	6,0	300	8,5
9787-060350A	9687-060350A	45/50(3,8)	6,0	350	9,5
9787-060400A	9687-060400A	45/50(3,8)	6,0	400	10,5
9787-060450A	9687-060450A	45/50(3,8)	6,0	450	11,5



## Einfachhaken verzinkt

Single hook zinc  
Gancho simple zincado  
Crochet simple zingué







15	25				
9790-080200A	9690-080200A	45/50(3,8)	8,0	200	11,8
9790-080300A	9690-080300A	45/50(3,8)	8,0	300	14,6
9790-080400A	9690-080400A	45/50(3,8)	8,0	400	18,7
9790-080500A	9690-080500A	45/50(3,8)	8,0	500	24,8
9791-100300A	9691-100300A	45/50(3,8)	10,0	300	22,5
9791-100400A	9691-100400A	45/50(3,8)	10,0	400	30,7
9791-100500A	9691-100500A	45/50(3,8)	10,0	500	36,2

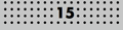
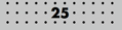

## Doppelhaken verzinkt

**Double hook** zinc  
**Gancho doble** zincado  
**Crochet double** zingué







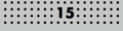
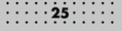

						
9794-034100A	9694-034100A	45/50(2,5)	3,4	100	50	2,5
9794-034150A	9694-034150A	45/50(2,5)	3,4	150	50	3,2
9794-034200A	9694-034200A	45/50(2,5)	3,4	200	50	3,9

## Doppelhaken verzinkt

**Double hook** zinc  
**Gancho doble** zincado  
**Crochet double** zingué







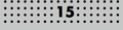
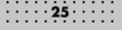

						
9122-034100A	9022-034100A	45/50(3,8)	3,4	100	50	3,0
9122-034150A	9022-034150A	45/50(3,8)	3,4	150	50	3,7
9122-034200A	9022-034200A	45/50(3,8)	3,4	200	50	4,4

## Doppelhaken verzinkt

**Double hook** zinc  
**Gancho doble** zincado  
**Crochet double** zingué







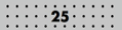

						
9307-040150A	9207-040150A	45/50(3,8)	4,0	150	50	4,8
9307-040200A	9207-040200A	45/50(3,8)	4,0	200	50	5,7
9307-040250A	9207-040250A	45/50(3,8)	4,0	250	50	6,6
9307-040300A	9207-040300A	45/50(3,8)	4,0	300	50	7,5

## Doppelhaken verzinkt

**Double hook** zinc  
**Gancho doble** zincado  
**Crochet double** zingué







						
9304-048200A	9204-048200A	45/50(3,8)	4,8	200	50	7,8
9304-048250A	9204-048250A	45/50(3,8)	4,8	250	50	9,4
9304-048300A	9204-048300A	45/50(3,8)	4,8	300	50	10,0
9304-048400A	9204-048400A	45/50(3,8)	4,8	400	50	12,2



## Doppelhaken verzinkt

**Double hook** zinc  
**Gancho doble** zincado  
**Crochet double** zingué





15	25					
9306-060200A	9206-060200A	45/50(3,8)	6,0	200	50	11,8
9306-060300A	9206-060300A	45/50(3,8)	6,0	300	50	16,3
9306-060400A	9206-060400A	45/50(3,8)	6,0	400	50	20,8

Mindestbestellmenge 1000 Stück je Sorte / minimum order quantity 1000 pieces  
Quantité minimale de commande: 1000 pièces / cantidad mínima por pedido: 1000 unidades



## Schwerlasthaken verzinkt

**Triple hook heavy type** zinc  
**Gancho triple cargas pesadas** zincado  
**Crochet triple** zingué





15	25					
2491582010	2490582010	45/50(3,8)	3,8/6,0	200	50	16,2
2491583010	2490583010	45/50(3,8)	3,8/6,0	300	50	17,3
2491584010	2490584010	45/50(3,8)	3,8/6,0	400	50	23,1
2491585010	2490585010	45/50(3,8)	3,8/6,0	500	50	29,0

Artikel nur auf Anfrage erhältlich / only on request / uniquement sur demande / solamente a pedido



## Schwerlasthaken verzinkt

**Triple hook heavy type** zinc  
**Gancho triple cargas pesadas** zincado  
**Crochet triple** zingué

15	25					
2491593010	2490593010	45/50(3,8)	3,8/8,0	300	50	18,3
2491594010	2490594010	45/50(3,8)	3,8/8,0	400	50	24,1
2491595010	2490595010	45/50(3,8)	3,8/8,0	500	50	30,0

Artikel nur auf Anfrage erhältlich / only on request / uniquement sur demande / solamente a pedido



## Einfachhaken für Lochwand Kunststoff

Single hook for pegboard plastics

Gancho simple para fondo perforado plástico

Crochet simple pour fond perforé plastique



	25						
8125390525	25		5,0	50	RAL9005	50	0,5
8125391025	25		5,0	100	RAL9005	50	0,7
8125391525	25		5,0	150	RAL9005	50	0,9
8125392025	25		5,0	200	RAL9005	50	1,1
8125390515	25		5,0	50	RAL9001	50	0,5
8125391015	25		5,0	100	RAL9001	50	0,7
8125391515	25		5,0	150	RAL9001	50	0,9
8125392015	25		5,0	200	RAL9001	50	1,1

Artikel nur auf Anfrage erhältlich / only on request / uniquement sur demande / solamente a pedido

## Einfachhaken für Papprückwand Kunststoff

Single hook for cardboard displays plastics

Gancho simple para expositor de carton plástico

Crochet simple pour display carton plastique



	25						
8124390525	25		5,0	50	RAL9005	50	0,5
8124391025	25		5,0	100	RAL9005	50	0,7
8124391525	25		5,0	150	RAL9005	50	0,9
8124392025	25		5,0	200	RAL9005	50	1,1
8124390515	25		5,0	50	RAL9001	50	0,5
8124391015	25		5,0	100	RAL9001	50	0,7
8124391515	25		5,0	150	RAL9001	50	0,9
8124392015	25		5,0	200	RAL9001	50	1,1

Artikel nur auf Anfrage erhältlich / only on request / uniquement sur demande / solamente a pedido

## Einfachhaken mit Klemmvorrichtung Kunststoff

Universal single hook with clip device plastics

Gancho simple universal con dispositivo de clip plástico

Crochet simple avec dispositif de blocage plastique



8123390525		20	5,0	50	RAL9005	50	0,4
8123391025		20	5,0	100	RAL9005	50	0,5
8123391525		20	5,0	150	RAL9005	50	0,6
8123390515		20	5,0	50	RAL9001	50	0,4
8123391015		20	5,0	100	RAL9001	50	0,5
8123391515		20	5,0	150	RAL9001	50	0,6

Artikel nur auf Anfrage erhältlich / only on request / uniquement sur demande / solamente a pedido

## Einfachhaken für Lamellenwand Kunststoff

Single hook for slatwall plastics

Gancho simple para lamas plástico

Crochet simple pour fond lame plastique









8122390525		25	5,0	50	RAL9005	50	0,7
8122391025		25	5,0	100	RAL9005	50	0,8
8122391525		25	5,0	150	RAL9005	50	1,1
8122392025		25	5,0	200	RAL9005	50	1,2
8122392525		25	5,0	250	RAL9005	50	1,3
8122390515		25	5,0	50	RAL9001	50	0,7
8122391015		25	5,0	100	RAL9001	50	0,8
8122391515		25	5,0	150	RAL9001	50	1,1
8122392015		25	5,0	200	RAL9001	50	1,2
8122392515		25	5,0	250	RAL9001	50	1,3

Artikel nur auf Anfrage erhältlich / only on request / uniquement sur demande / solamente a pedido

## Doppelhaken für Lochwand Kunststoff

Double hook for pegboard plastics  
Gancho doble para fondo perforado plastico  
Crochet double pour fond perforé plastique







 25	 mm	 mm	 mm			 kg
8125400525	25	5,0	50	RAL9005	50	0,7
8125401025	25	5,0	100	RAL9005	50	1,0
8125401525	25	5,0	150	RAL9005	50	1,3
8125402025	25	5,0	200	RAL9005	50	1,6
8125400515	25	5,0	50	RAL9001	50	0,7
8125401015	25	5,0	100	RAL9001	50	1,0
8125401515	25	5,0	150	RAL9001	50	1,3
8125402015	25	5,0	200	RAL9001	50	1,6

Artikel nur auf Anfrage erhältlich / only on request / uniquement sur demande / solamente a pedido



## Doppelhaken für Papprückwand Kunststoff

Double hook for cardboard displays plastics  
Gancho doble para expositor de carton plastico  
Crochet double pour display carton plastique







 25	 mm	 mm	 mm			 kg
8124400525	25	5,0	50	RAL9005	50	0,7
8124401025	25	5,0	100	RAL9005	50	1,0
8124401525	25	5,0	150	RAL9005	50	1,3
8124402025	25	5,0	200	RAL9005	50	1,6
8124400515	25	5,0	50	RAL9001	50	0,7
8124401015	25	5,0	100	RAL9001	50	1,0
8124401515	25	5,0	150	RAL9001	50	1,3
8124402015	25	5,0	200	RAL9001	50	1,6

Artikel nur auf Anfrage erhältlich / only on request / uniquement sur demande / solamente a pedido



## Blisterhaken mit Klemmvorrichtung Kunststoff

Universal double hook with clip device plastics  
Gancho doble universal con dispositivo de clip plastico  
Crochet double avec dispositif de blocage plastique







	 mm	 mm	 mm			 kg
8123410525	20	5,0	50	RAL9005	50	0,6
8123411025	20	5,0	100	RAL9005	50	0,7
8123411525	20	5,0	150	RAL9005	50	0,8
8123410515	20	5,0	50	RAL9001	50	0,6
8123411015	20	5,0	100	RAL9001	50	0,7
8123411515	20	5,0	150	RAL9001	50	0,8

Artikel nur auf Anfrage erhältlich / only on request / uniquement sur demande / solamente a pedido



## Doppelhaken für Lamellenwand Kunststoff

Double hook for slatwall plastics  
Gancho doble para lamas plastico  
Crochet double pour fond lame plastique

	 mm	 mm	 mm			 kg
8122400525	30	5,0	50	RAL9005	50	0,8
8122401025	30	5,0	100	RAL9005	50	1,1
8122401525	30	5,0	150	RAL9005	50	1,4
8122402025	30	5,0	200	RAL9005	50	1,7
8122402525	30	5,0	250	RAL9005	50	2,0
8122400515	30	5,0	50	RAL9001	50	0,8
8122401015	30	5,0	100	RAL9001	50	1,1
8122401515	30	5,0	150	RAL9001	50	1,4
8122402015	30	5,0	200	RAL9001	50	1,7
8122402515	30	5,0	250	RAL9001	50	2,0

Artikel nur auf Anfrage erhältlich / only on request / uniquement sur demande / solamente a pedido



# HOHAGE

Wir biegen Lösungen

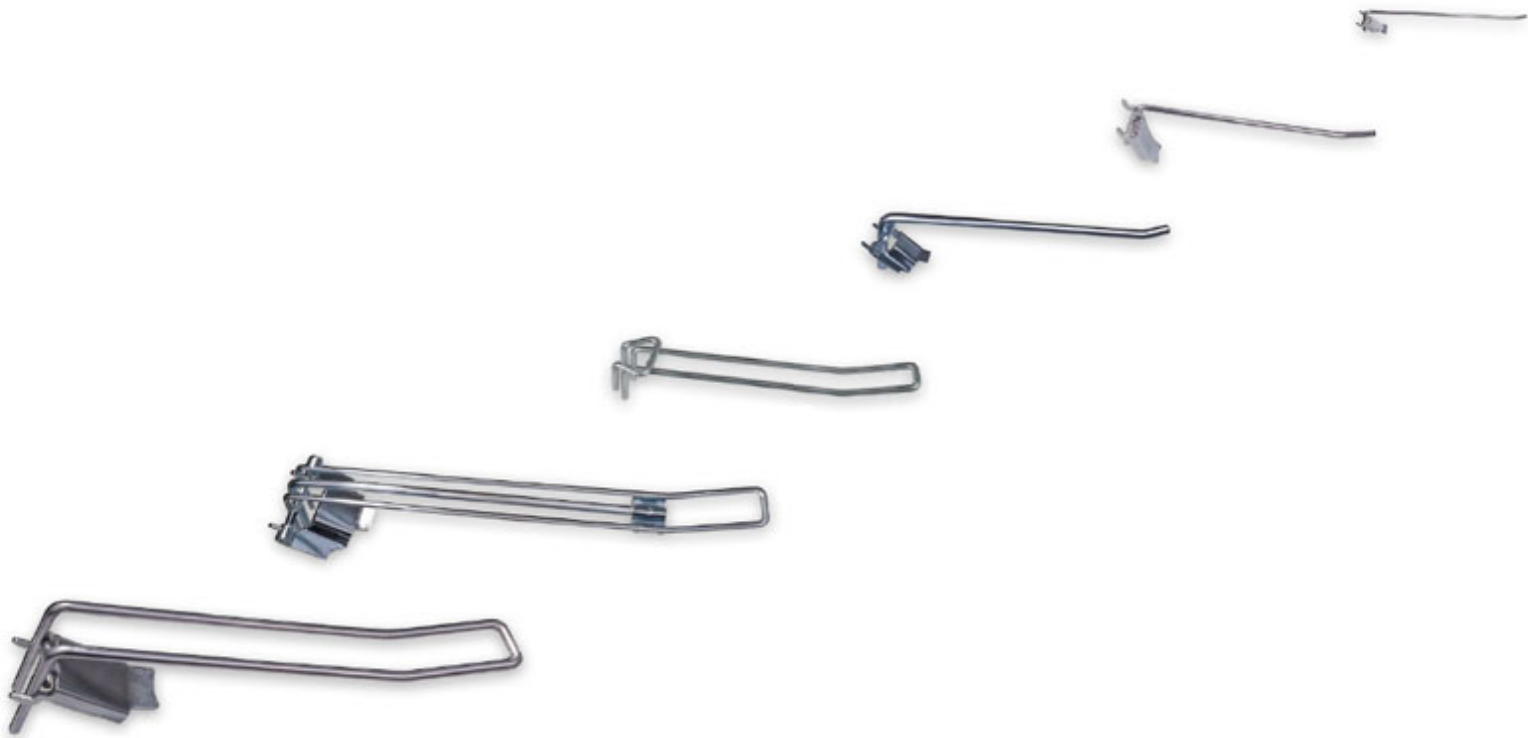

## **Systemhaken mit Schnellbefestigung**

Fast entry hooks  
Ganchos con cierre giratorio  
Crochets à système

## Einfachhaken mit Klappverschluss verzinkt

Single hook with locking device zinc  
 Gancho simple con cierre basculante zincado  
 Crochet simple avec arrêt de sécurité zingué



15	25	mm	mm	mm	kg
3140651042	3040661042	30/25	4,8	100	7,7
3140651542	3040661542	30/25	4,8	150	8,4
3140652042	3040662042	30/25	4,8	200	9,1
3140652542	3040662542	30/25	4,8	250	9,8
3140653042	3040663042	30/25	4,8	300	10,5
3140654042	3040664042	30/25	4,8	400	12,0

## Einfachhaken mit Klappverschluss verzinkt

Single hook with locking device zinc  
 Gancho simple con cierre basculante zincado  
 Crochet simple avec arrêt de sécurité zingué



15	25	mm	mm	mm	kg
3030062042	-	30	6,0	200	11,0
3030063042	-	30	6,0	300	13,4
3030064042	-	30	6,0	400	15,7

## Einfachhaken mit Klappverschluss verzinkt

Single hook with locking device zinc  
 Gancho simple con cierre basculante zincado  
 Crochet simple avec arrêt de sécurité zingué



15	25	mm	mm	mm	kg
3030082042	-	30	8,0	200	12,1
3030083042	-	30	8,0	300	14,5
3030084042	-	30	8,0	400	16,8

## Einfachhaken mit Klappverschluss verzinkt

Single hook with locking device zinc  
 Gancho simple con cierre basculante zincado  
 Crochet simple avec arrêt de sécurité zingué







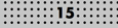
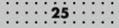

15	25	mm	mm	mm	kg
4501062010	5001062010*	45/50	6,0	200	12,0
4501063010	5001063010*	45/50	6,0	300	14,4
4501064010	5001064010*	45/50	6,0	400	16,7

\* Artikel nur auf Anfrage erhältlich / only on request / uniquement sur demande / solamente a pedido

## Einfachhaken mit Klappverschluss verzinkt

Single hook with locking device zinc  
 Gancho simple con cierre basculante zincado  
 Crochet simple avec arrêt de sécurité zingué







 15	 25					
4501082010	5001082010*	45/50	8,0	200	50	13,1
4501083010	5001083010*	45/50	8,0	300	50	15,5
4501084010	5001084010*	45/50	8,0	400	50	17,8
4501085010	5001085010*	45/50	8,0	500	25	20,1

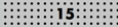
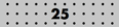

\* Artikel nur auf Anfrage erhältlich / only on request / uniquement sur demande / solamente a pedido

## Einfachhaken mit Klappverschluss verzinkt

Single hook with locking device zinc  
 Gancho simple con cierre basculante zincado  
 Crochet simple avec arrêt de sécurité zingué

 15	 25					
4501103010	5001103010*	45/50	10,0	300	25	29,0
4501104010	5001104010*	45/50	10,0	400	25	35,3
4501105010	5001105010*	45/50	10,0	500	25	41,5



\* Artikel nur auf Anfrage erhältlich / only on request / uniquement sur demande / solamente a pedido

## Rutschhaken mit Klappverschluss verzinkt

Slide hook with locking device zinc

Gancho doble inclinado con cierre basculante zincado

Crochet de glissement avec arrêt de sécurité zingué



15	25	mm	mm	mm	kg	
3097703542	-	30	4,8	350	50	15,5

## Doppelhaken mit Klappverschluss verzinkt

Double hook with locking device zinc

Gancho doble con cierre basculante zincado

Crochet double avec arrêt de sécurité zingué



15	25	mm	mm	mm	kg	
3040538042	-	30	4,0	80	50	5,9
3009341042	-	30	4,0	100	50	6,1
3009340242	-	30	4,0	120	50	6,5
3009340342	-	30	4,0	150	50	7,0
3109792042	3009762042*	30/25	4,8	200	50	9,4
3109792542	3009762542*	30/25	4,8	250	50	10,1
3109793042	3009763042*	30/25	4,8	300	50	10,8
3109794042	3009764042*	30/25	4,8	400	50	12,3

\* Artikel nur auf Anfrage erhältlich / only on request / uniquement sur demande / solamente a pedido

## Doppelhaken mit Klappverschluss verzinkt

Double hook with locking device zinc

Gancho doble con cierre basculante zincado

Crochet double avec arrêt de sécurité zingué



15	25	mm	mm	mm	kg	
4502052010	5002052010*	45/50	4,8	200	50	14,0
4502053010	5002053010*	45/50	4,8	300	50	16,9
4502054010	5002054010*	45/50	4,8	400	50	19,8

\* Artikel nur auf Anfrage erhältlich / only on request / uniquement sur demande / solamente a pedido

## Doppelhaken mit Klappverschluss verzinkt

Double hook with locking device zinc

Gancho doble con cierre basculante zincado

Crochet double avec arrêt de sécurité zingué



15	25	mm	mm	mm	kg	
4502062010	5002062010*	45/50	6,0	200	50	18,5
4502063010	5002063010*	45/50	6,0	300	50	21,4
4502064010	5002064010*	45/50	6,0	400	50	24,3

\* Artikel nur auf Anfrage erhältlich / only on request / uniquement sur demande / solamente a pedido



## Schwerlasthaken mit Klappverschluss verzinkt

Triple hook heavy type with locking device zinc

Gancho triple con cierre basculante zincado

Crochet lourd triple avec arrêt de sécurité zingué

15	25	mm	mm	mm	mm	kg
4563042510*	5063042510*	45/50	3,8/6,0	250	50	20,5
4563043010	5063043010*	45/50	3,8/6,0	300	50	23,4
4563044010*	5063044010*	45/50	3,8/6,0	400	50	26,3



\* Mindestbestellmenge 500 Stück / minimum order quantity 500 pieces

\* Quantité minimale de commande: 500 pièces / cantidad mínima por pedido: 500 unidades

## Schwerlasthaken mit Klappverschluss verzinkt

Triple hook heavy type with locking device zinc

Gancho triple con cierre basculante zincado

Crochet lourd triple avec arrêt de sécurité zingué

15	25	mm	mm	mm	mm	kg
4583042510*	5083042510*	45/50	3,8/8,0	250	50	22,5
4583043010*	5083043010*	45/50	3,8/8,0	300	50	25,4
4583044010	5083044010*	45/50	3,8/8,0	400	50	28,3
4583045010**	5083045010**	45/50	3,8/8,0	500	50	31,2



\* Mindestbestellmenge 500 Stück / minimum order quantity 500 pieces

\* Quantité minimale de commande: 500 pièces / cantidad mínima por pedido: 500 unidades

\*\* Artikel nur auf Anfrage erhältlich / only on request / uniquement sur demande / solamente a pedido

## Doppelhaken offen mit Klappverschluss innere Weite ca. 40 mm, verzinkt

Double hook open with locking device inner width approx. 40 mm, zinc

Gancho doble abierto con cierre basculante aprox. 40 mm, zincado

Crochet double ouvert avec arrêt de sécurité largeur intérieure env. 40 mm, zingué

15	25	mm	mm	mm	mm	kg
7505082010		75	8,0	200	25	29,0
7505083010		75	8,0	300	25	37,1
7505084010		75	8,0	400	25	45,1
7505085010		75	8,0	500	25	53,2



Mindestbestellmenge 500 Stück je Sorte / minimum order quantity 500 pieces

Quantité minimale de commande: 500 pièces / cantidad mínima por pedido: 500 unidades

## Doppelhaken offen mit Klappverschluss innere Weite ca. 40 mm, verzinkt

Double hook open with locking device inner width approx. 40mm, zinc

Gancho doble abierto con cierre basculante aprox. 40mm, zincado

Crochet double ouvert avec arrêt de sécurité largeur intérieure env. 40 mm, zingué

15	25	mm	mm	mm	mm	kg
7505103010		75	10,0	300	25	54,6
7505104010		75	10,0	400	25	67,2
7505105010		75	10,0	500	25	79,8



Artikel nur auf Anfrage erhältlich / only on request / uniquement sur demande / solamente a pedido

## System-Steckplatte verzinkt

System plate zinc  
Placa sistema zincado  
Platine renforcée zinguée



15	25	mm	mm				kg
2415490302	-	30	85			50	3,6

## Einfachhaken für System-Steckplatte verzinkt

Single hook for special system plate zinc  
Gancho simple para placa sistema zincado  
Crochet simple pour platine renforcée zingué



15		mm	mm	mm	mm		kg
2415632902		30		4,8	200	50	5,0
2415633902		30		4,8	300	50	6,7
2415634902		30		4,8	400	50	8,5

Mindestbestellmenge 500 Stück je Sorte / minimum order quantity 500 pieces  
Quantité minimale de commande: 500 pièces / cantidad mínima por pedido: 500 unidades

## Einfachhaken für System-Steckplatte verzinkt

Single hook for special system plate zinc  
Gancho simple para placa sistema zincado  
Crochet simple pour platine renforcée zingué



15		mm	mm	mm	mm		kg
2415652902		30		6,0	200	50	7,6
2415653902		30		6,0	300	50	9,9
2415654902		30		6,0	400	50	12,1

Mindestbestellmenge 500 Stück / minimum order quantity 500 pieces  
Quantité minimale de commande: 500 pièces / cantidad mínima por pedido: 500 unidades

## Einfachhaken für System-Steckplatte verzinkt

Single hook for special system plate zinc  
Gancho simple para placa sistema zincado  
Crochet simple pour platine renforcée zingué



15		mm	mm	mm	mm		kg
2415672902*		30		8,0	200	25	12,2
2415673902*		30		8,0	300	25	16,4
2415674902*		30		8,0	400	25	20,2
2415675902**		30		8,0	500	25	24,8

\* Mindestbestellmenge 500 Stück / minimum order quantity 500 pieces  
\* Quantité minimale de commande: 500 pièces / cantidad mínima por pedido: 500 unidades  
\*\* Artikel nur auf Anfrage erhältlich / only on request / uniquement sur demande / solamente a pedido

## Doppelhaken für System-Steckplatte verzinkt

Double hook for special system plate zinc  
 Gancho doble para placa sistema zincado  
 Crochet double pour platine renforcée zingué

15:		mm	mm	mm		kg
2415762042		30	4,8	200	50	9,2
2415763042		30	4,8	300	50	11,8
2415764042		30	4,8	400	50	14,8



## Schwerlasthaken für System-Steckplatte verzinkt

Triple hook heavy type for special system plate zinc  
 Gancho triple reforzado para placa sistema zincado  
 Crochet lourd triple pour platine renforcée zingué

15:		mm	mm	mm		kg
2415583010**		30	3,8/6,0	300	25	17,6
2415584010**		30	3,8/6,0	400	25	21,7
2415585010**		30	3,8/6,0	500	25	25,8
2415603010*		30	3,8/8,0	300	25	23,3
2415604010*		30	3,8/8,0	400	25	29,1
2415605010**		30	3,8/8,0	500	25	35,0



\* Mindestbestellmenge 500 Stück / minimum order quantity 500 pieces  
 \* Quantité minimale de commande: 500 pièces / cantidad mínima por pedido: 500 unidades  
 \*\* Artikel nur auf Anfrage erhältlich / only on request / uniquement sur demande / solamente a pedido

# HOHAGE

Wir biegen Lösungen



## **Systemhaken mit Preisauszeichnung / Zubehör**

**System hooks with price labelling / Accessories**

**Ganchos con portaprecios / Accesorios**

**Crochets à système avec affichage du prix / Accessoires**

## Einfachhaken mit Etikettenträger verzinkt

Single hook with top label holder zinc

Gancho simple con tope etiqueta zincado

Crochet simple équipé d'un bras porte-prix zingué



15	25	mm	mm	mm	kg	
6093401542	6092401510	30/25(3,4)	4,8	150	50	5,7
6093402042	6092402010	30/25(3,4)	4,8	200	50	7,0
6093402542	6092402510	30/25(3,4)	4,8	250	50	8,2
6093403042	6092403010	30/25(3,4)	4,8	300	50	9,6
6093404042	6092404010	30/25(3,4)	4,8	400	50	12,2

Die passenden Pendeltaschen finden Sie auf der Seite 35.

## Einfachhaken mit Etikettenträger verzinkt

Single hook with top label holder zinc

Gancho simple con tope etiqueta zincado

Crochet simple équipé d'un bras porte-prix zingué



15	25	mm	mm	mm	kg	
6097872010	6096872010	45/50(3,8)	6,0	200	50	11,5
6097873010	6096873010	45/50(3,8)	6,0	300	50	16,5
6097874010	6096874010	45/50(3,8)	6,0	400	50	21,5
6097903010	6096903010	45/50(3,8)	8,0	300	25	18,6
6097904010	6096904010	45/50(3,8)	8,0	400	25	23,6

Die passenden Pendeltaschen finden Sie auf der Seite 35.

## Einfachhaken mit Klappverschluss und Etikettenträger verzinkt

Single hook with locking device and top label holder zinc

Gancho simple con cierre basculante y tope etiqueta zincado

Crochet simple avec arrêt de sécurité et bras porte-prix zingué



15	25	mm	mm	mm	kg	
6030062042	-	30	6,0	200	25	11,7
6030063042	-	30	6,0	300	25	17,6
6030064042	-	30	6,0	400	25	23,4

Die passenden Pendeltaschen finden Sie auf der Seite 35.

## Einfachhaken mit Klappverschluss und Etikettenträger verzinkt

Single hook with locking device and top label holder zinc

Gancho simple con cierre basculante y tope etiqueta zincado

Crochet simple avec arrêt de sécurité et bras porte-prix zingué



15	25	mm	mm	mm	kg	
6030082042	-	30	8,0	200	25	15,6
6030083042	-	30	8,0	300	25	23,4
6030084042	-	30	8,0	400	25	31,2

Die passenden Pendeltaschen finden Sie auf der Seite 35.

## Einfachhaken mit Klappverschluss und Etikettenträger verzinkt

Single hook with locking device and top label holder zinc  
 Gancho simple con cierre basculante y tope etiqueta zincado  
 Crochet simple avec arrêt de sécurité et bras porte-prix zingué

15	25	mm	mm	mm	mm	kg
6140651542	-	30	4,8	150	50	7,3
6140652042	-	30	4,8	200	50	9,2
6140652542	-	30	4,8	250	50	11,1
6140653042	-	30	4,8	300	50	13,0
6140654042	-	30	4,8	400	50	16,8



Die passenden Pendeltaschen finden Sie auf der Seite 35.

## Einfachhaken mit Klappverschluss und Etikettenträger verzinkt

Single hook with locking device and top label holder zinc  
 Gancho simple con cierre basculante y tope etiqueta zincado  
 Crochet simple avec arrêt de sécurité et bras porte-prix zingué

15	25	mm	mm	mm	mm	kg
6045062010	6050062010*	45/50	6,0	200	50	15,2
6045063010	6050063010*	45/50	6,0	300	50	18,5
6045064010	6050064010*	45/50	6,0	400	50	21,7



\* Artikel nur auf Anfrage erhältlich / only on request / uniquement sur demande / solamente a pedido  
 Die passenden Pendeltaschen finden Sie auf der Seite 35.

## Einfachhaken mit Klappverschluss und Etikettenträger verzinkt

Single hook with locking device and top label holder zinc  
 Gancho simple con cierre basculante y tope etiqueta zincado  
 Crochet simple avec arrêt de sécurité et bras porte-prix zingué

15	25	mm	mm	mm	mm	kg
6045082010	6050082010*	45/50	8,0	200	50	19,3
6045083010	6050083010*	45/50	8,0	300	50	24,6
6045084010	6050084010*	45/50	8,0	400	50	29,5



\* Artikel nur auf Anfrage erhältlich / only on request / uniquement sur demande / solamente a pedido  
 Die passenden Pendeltaschen finden Sie auf der Seite 35.

## Etikettenträger mit Klappverschluss verzinkt

Label holder with locking device zinc  
 Portaetiqueta con cierre basculante zincado  
 Bras porte-prix avec arrêt de sécurité zingué

15	25	mm	mm	mm	mm	kg
6040622010	6039622010	30/25	4,8	200	50	5,8
6040622510	6039622510	30/25	4,8	250	50	7,6
6040623510	6039623510	30/25	4,8	350	50	8,9
6040624510	6039624510	30/25	4,8	450	50	10,2
6040625510	6039625510	30/25	4,8	550	50	13,9



Mindestbestellmenge 500 Stück je Sorte / minimum order quantity 500 pieces  
 Quantité minimale de commande: 500 pièces / cantidad mínima por pedido: 500 unidades  
 Die passenden Pendeltaschen finden Sie auf der Seite 35.

## Doppelhaken mit Etikettenträger verzinkt

Double hook with top label holder zinc

Gancho doble con tope etiqueta zincado

Crochet double équipé d'un bras porte-prix zingué



15	25	mm (mm)	mm	mm	kg	
6091221542	6090221542	45/50(3,8)	3,4	150	50	6,2
6091222042	6090222042	45/50(3,8)	3,4	200	50	7,4

Die passenden Pendeltaschen finden Sie auf der Seite 35.

## Doppelhaken mit Etikettenträger verzinkt

Double hook with top label holder zinc

Gancho doble con tope etiqueta zincado

Crochet double équipé d'un bras porte-prix zingué



15	25	mm (mm)	mm	mm	kg	
6093072042	6092072042	45/50(3,8)	4,0	200	50	8,7
6093073042	6092073042	45/50(3,8)	4,0	300	50	9,9

Die passenden Pendeltaschen finden Sie auf der Seite 35.

## Doppelhaken mit Etikettenträger verzinkt

Double hook with top label holder zinc

Gancho doble con tope etiqueta zincado

Crochet double équipé d'un bras porte-prix zingué



15	25	mm (mm)	mm	mm	kg	
6093042042	6092042042	45/50(3,8)	4,8	200	50	10,6
6093042542	6092042542	45/50(3,8)	4,8	250	50	12,8
6093043042	6092043042	45/50(3,8)	4,8	300	50	14,4

Die passenden Pendeltaschen finden Sie auf der Seite 35.

## Doppelhaken mit Klappverschluss und Etikettenträger verzinkt

Double hook with locking device and top label holder zinc

Gancho doble con cierre basculante y tope etiqueta zincado

Crochet double avec arrêt de sécurité et bras porte-prix zingué



15	25	mm (mm)	mm	mm	kg	
6009341042	-	30	4,0	100	50	7,1
6009340242	-	30	4,0	120	50	7,5
6009340342	-	30	4,0	150	50	9,0
6109791542	6009761542*	30/25	4,8	150	50	10,5
6109792042	6009762042*	30/25	4,8	200	50	12,8
6109792542	6009762542*	30/25	4,8	250	50	15,1
6109793042	6009763042*	30/25	4,8	300	50	17,4
6109794042	6009764042*	30/25	4,8	400	50	22,0

\* Artikel nur auf Anfrage erhältlich / only on request / uniquement sur demande / solamente a pedido  
Die passenden Pendeltaschen finden Sie auf der Seite 35.



## Schwerlasthaken mit Klappverschluss und Etikettenträger verzinkt

Triple hook heavy type with locking device and top label holder zinc  
 Gancho triple cargas pesadas con cierre basculante y tope etiqueta zincado  
 Crochet lourd triple avec arrêt de sécurité et bras porte-prix zingué

15	25	mm	mm	mm			kg
6063043010**	6062043010**	45/50	3,8/6,0	300		50	24,0
6083043010*	6082043010*	45/50	3,8/8,0	300		50	29,4
6083044010*	6082044010*	45/50	3,8/8,0	400		50	35,3



\* Mindestbestellmenge 1000 Stück / minimum order quantity 1000 pieces  
 \* Quantité minimale de commande: 1000 pièces / cantidad mínima por pedido: 1000 unidades  
 \*\* Artikel nur auf Anfrage erhältlich / only on request / uniquement sur demande / solamente a pedido  
 Die passenden Pendeltaschen finden Sie auf der Seite 35.

## Einfachhaken mit seitlichem Etikettenträger verzinkt

Single hook with locking device and lateral label holder zinc  
 Gancho simple con porta-etiquetas lateral zincado  
 Crochet simple avec arrêt de sécurité et bras porte-prix latéral zingué

15	25	mm	mm	mm			kg
3040652010K**	-	30	4,8	200		50	10,1
3040653010K*	-	30	4,8	300		50	11,8



\* Mindestbestellmenge 500 Stück / minimum order quantity 500 pieces  
 \* Quantité minimale de commande: 500 pièces / cantidad mínima por pedido: 500 unidades  
 \*\* Artikel nur auf Anfrage erhältlich / only on request / uniquement sur demande / solamente a pedido

## Einfachhaken mit Klappverschluss und Etikettenträger mit Metallfahne verzinkt

Single hook with locking device and label holder with metal price flag zinc  
 Gancho simple con cierre basculante, porta-etiquetas con portaprecio metálico zincado  
 Crochet simple avec arrêt de sécurité et bras porte-prix et étiquette métallique zingué

15	25	mm	mm	mm	mm		kg
304065201028*	-	30	4,8	200	28x28(35)	50	11,2
304065011028*	-	30	4,8	300	28x28(35)	50	14,0
304065031028*	-	30	4,8	400	28x28(35)	50	16,8
304065151052*	-	30	4,8	150	28x30(52)	50	8,4
304065201052*	-	30	4,8	200	28x30(52)	50	11,2
304065301052*	-	30	4,8	300	28x30(52)	50	14,0
304065031052*	-	30	4,8	400	28x30(52)	50	16,8



\* Artikel nur auf Anfrage erhältlich / only on request / uniquement sur demande / solamente a pedido

## Einfachhaken mit Etikettenträger und Metallfahne 40 x 30 mm verzinkt

Single hook with label holder and metal price flag 40 x 30 mm zinc  
 Gancho simple con porta-etiquetas y portaprecio metálico 40 x 30 mm zincado  
 Crochet simple avec bras porte-prix et étiquette métallique 40 x 30 mm zingué

15	25	mm (mm)	mm	mm			kg
2491612042	2490612042	45/50(3,8)		4,8	200	50	9,8
2491613042	2490613042	45/50(3,8)		4,8	300	50	12,7
2491614042	2490614042	45/50(3,8)		4,8	400	50	15,6



Mindestbestellmenge 1000 Stück je Sorte / minimum order quantity 1000 pieces  
 Quantité minimale de commande: 1000 pièces / cantidad mínima por pedido: 1000 unidades

## Doppelhaken mit Etikettenträger und Metallfahne 40 x 30 mm verzinkt

Double hook with label holder and metal price flag 40 x 30 mm zinc

Gancho doble con porta-etiquetas y portaprecio metálico 40 x 30 mm zincado

Crochet double avec bras porte-prix et étiquette métallique 40 x 30 mm zingué



15	25	mm	mm	mm	mm	kg
2491602042	2490602042	45/50(3,8)	4,8	200	50	12,3
2491603042	2490603042	45/50(3,8)	4,8	300	50	18,6
2491604042	2490604042	45/50(3,8)	4,8	400	50	24,9

Artikel nur auf Anfrage erhältlich / only on request / uniquement sur demande / solamente a pedido

## Doppelhaken mit Klappverschluss und Metallfahne 28 x 28 mm verzinkt

Double hook with locking device and metal price flag 28 x 28 mm zinc

Gancho doble con cierre basculante y portaprecio metálico 28 x 28 mm zincado

Crochet double avec arrêt de sécurité et étiquette métallique 28 x 28 mm zingué



15	25	mm	mm	mm	mm	kg
310979204228	-	30	4,8	200	50	13,3
310979304228	-	30	4,8	300	50	16,4
310979404228	-	30	4,8	400	50	19,5

## Doppelhaken mit Klappverschluss und Metallfahne 28 x 52 mm verzinkt

Double hook with locking device and metal price flag 28 x 52 mm zinc

Gancho doble con cierre basculante y portaprecio metálico 28 x 52 mm zincado

Crochet double avec arrêt de sécurité et étiquette métallique 28 x 52 mm zingué



15	25	mm	mm	mm	mm	kg
310979204252	-	30	4,8	200	50	13,3
310979304252	-	30	4,8	300	50	16,4
310979404252	-	30	4,8	400	50	19,5

## Doppelhaken für Sysem-Steckplatte mit Metallfahne 52 x 28 mm verzinkt

Double hook for special system plate with metal price flag 52 x 28 mm zinc

Gancho doble para placa sistema con portaprecio metálico 52 x 28 mm zincado

Crochet double pour platine renforcée avec étiquette métallique 52 x 28 mm zingué



15	25	mm	mm	mm	mm	kg
241576204252	-	30	4,8	200	50	9,8
241576304252	-	30	4,8	300	50	12,4
241576404252	-	30	4,8	400	50	15,4

## System-Steckplatte verzinkt

System plate zinc  
Placa sistema zincado  
Platine renforcée zinguée

15	25	mm	mm			
2415490302	-	30	85		50	3,6



## Pendeltasche für Etikettenträger transparent

Clear plastic price label jacket to fit on label holder  
Funda de plástico transparente para etiqueta de precio  
Porte-étiquette plastique pour broche en T

		axb mm axc mm axb2 mm				
1250014426		44x26			50	0,3
1250002650		52x26			50	0,4
1250002656		56x26			50	0,4
1250002670		70x26			50	0,4



## Pendeltasche für Etikettenträger transparent

Clear plastic price label jacket to fit on label holder  
Funda de plástico transparente para etiqueta de precio  
Porte-étiquette plastique pour broche en T

		axb mm axc mm axb2 mm				
1250014040		40x40			50	0,4
1250014045		45x40			50	0,5
1250014500		52x40			50	0,6
1250014060		60x40			50	0,6
1250014070		70x40			50	0,6
1250014800		80x40			50	0,8
1250014900		90x40			50	1,0
12500140100		100x40			50	1,0
1250016500		105x40			50	1,1
1250016600		110x40			50	1,2



## Pendeltasche für Etikettenträger transparent

Clear plastic price label jacket to fit on label holder  
Funda de plástico transparente para etiqueta de precio  
Porte-étiquette plastique pour broche en T

		axb mm axc mm axb2 mm				
1250015237		37x52			50	0,6
1250015252		52x52			50	0,7
1250015260		60x52			50	0,7
1250015280		80x52			50	0,8







## Kunststoff-Fahne weiß mit Anlegesteg

Price flag made of white plastics

Porta-precio de plástico blanco

Etiquette en plastique blanche clipsable



				 mm	 $\frac{a \times b}{c \times d}$ mm		 kg
1240014000				<=4,8	27x40(52)	50	0,1





## Kunststoff-Fahne weiß ohne Anlegesteg

Price flag made of white plastics

Porta-precio de plástico blanco

Etiquette en plastique blanche clipsable



				 mm	 $\frac{a \times b}{c \times d}$ mm		 kg
1240015000				<=4,8	27x27(37)	50	0,1
1240524000				<=4,8	27x42(52)	50	0,1
1240014500				<=6,0	27x42(52)	50	0,1





## Kunststoff-Fahne transparent

Clear plastic price flag with flag window

Indicador de precios de plástico transparente con ventana

Etiquette en plastique transparent clipsable, avec fenêtre



				 mm	 $\frac{a \times b}{c \times d}$ mm		 kg
1240062626				<=4,8	26x26(50)	100	0,1
1240062642				<=4,8	26x42(60)	100	0,1





## Metallfahne zum Nachrüsten

Metal price flag

Portaprecio de metal

Etiquette en métal



				 mm	 $\frac{a \times b}{c \times d}$ mm		 kg
4000700200				4,8	17,5x25(33)	50	0,1
4000700400				3,8	25x25(37)	50	0,3
4000700300				4,8	25x25(37)	50	0,3

## Metallfahne zum Nachrüsten

Metal price flag  
Portaprecio de metal  
Etiquette en métal

				mm	28x28(35) 28x28(35) 28x28(35)	50	kg
4000510300				3,8	28x28(35)	50	0,4
4000520300				4,8	28x28(35)	50	0,4
4000510500				6,0	28x28(35)	50	0,4



## Metallfahne zum Nachrüsten

Metal price flag  
Portaprecio de metal  
Etiquette en métal

				mm	28x30(52) 28x30(52) 28x30(52)	50	kg
4000765000				3,8	28x30(52)	50	0,6
4000765200				4,8	28x30(52)	50	0,6
4000765500				6,0	28x30(52)	50	0,6



## Kunststoff-Adapter für Einfachhaken weiß

Adapter made of white plastics, for single hook  
Adaptador plástico blanco, para gancho simple  
Adaptateur en plastique blanc, pour crochet simple

				mm			kg
1240013010				6,0		100	0,2
1240013040				7,0		100	0,2
1240013020				8,0		100	0,2
1240013030				10,0		100	0,2
1240013050				12,0		250	0,3



## Metall-Adapter mit Fahne für Einfachhaken

Metal adapter with price flag, for single hook  
Adaptador metálico con portaprecios, para gancho simple  
Adaptateur en métal, avec porte-étiquette, pour crochet simple

				mm	28x35 28x41 28x52		kg
400014-				-	28x35	-	-
400017-				-	28x41	-	-
400013-				-	28x52	-	-
-0510				3,8	-	100	0,8
-0610				4,8	-	100	0,9
-0310				6,0	-	100	0,9
-0210				7,0	-	100	0,9
-0410				8,0	-	100	0,9
-0010				10,0	-	100	1,0
-0110				12,0	-	100	1,0







## Kunststoff-Klemmstopper für Einfachhaken transparent

Stopper made of clear plastics, suitable for single hook

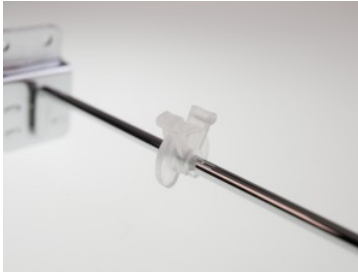
Tope de plástico para gancho simple

Limiteur de stock en plastique, pour crochet simple



							
1202000400				4,8	transparent	100	0,2
1202000600				6,0	transparent	100	0,2
1202000800				8,0	transparent	100	0,2
1202001000				10,0	transparent	100	0,2





## Kunststoff-Klemmstopper für Einfachhaken

Stopper made of clear plastics, suitable for single hook

Tope de plástico para gancho simple

Limiteur de stock en plastique, pour crochet simple



							
1202000200				4,0-4,8	transparent	200	0,2
1202000100				4,0-4,8	RAL9005	200	0,2



## Metall-Klemmstopper für Doppelhaken

Stopper made of metal, suitable for double hook

Tapón de metal para ganchos doble

Limiteur de stock en métal, pour broche double



							
2402000100				2,5-6,0		50	0,3



## Kunststoff-Schloss transparent

Lock for hooks made of clear plastic

Bloqueo para gancho plástico transparente

Serrure en plastique transparent





							
1300400500				>=4,8		50	1,0

Wir biegen Lösungen

## Kunststoff-Schloss weiß





Lock for hooks made of white plastic  
 Bloqueo para gancho plástico blanco  
 Serrure en plastique blanc

				 mm			 kg
1300400400				>=4,8		50	1,0



## Kunststoff-Schloss mit Schließzylinder





Lock made of plastics (with metal cylinder lock)  
 Cerradura de plástico (cierre metálico)  
 Serrure en plastique (barillet en métal)

				 mm			 kg
1300100200				>=4,8	transparent	50	3,8



## Kunststoff-Kappen für Einfachhaken schwarz und weiß

Rubber cap, black and white colour, suitable for single hook  
 Casquillo de goma, blanco o negro, para gancho simple  
 Capuchon plastique, noir et blanc, pour crochet simple

		 mm				 kg
1201003420		3,4		RAL9005	100	0,1
1201004020		4,0		RAL9005	100	0,1
1201004820		4,8		RAL9005	100	0,1
1201006020		6,0		RAL9005	100	0,1
1201008020		8,0		RAL9005	100	0,2
1201010020		10,0		RAL9005	100	0,2
1201003410		3,4		RAL9001	100	0,1
1201004010		4,0		RAL9001	100	0,1
1201004810		4,8		RAL9001	100	0,1
1201006010		6,0		RAL9001	100	0,1
1201008010		8,0		RAL9001	100	0,2
1201010010		10,0		RAL9001	100	0,2



# HOHAGE

Wir biegen Lösungen

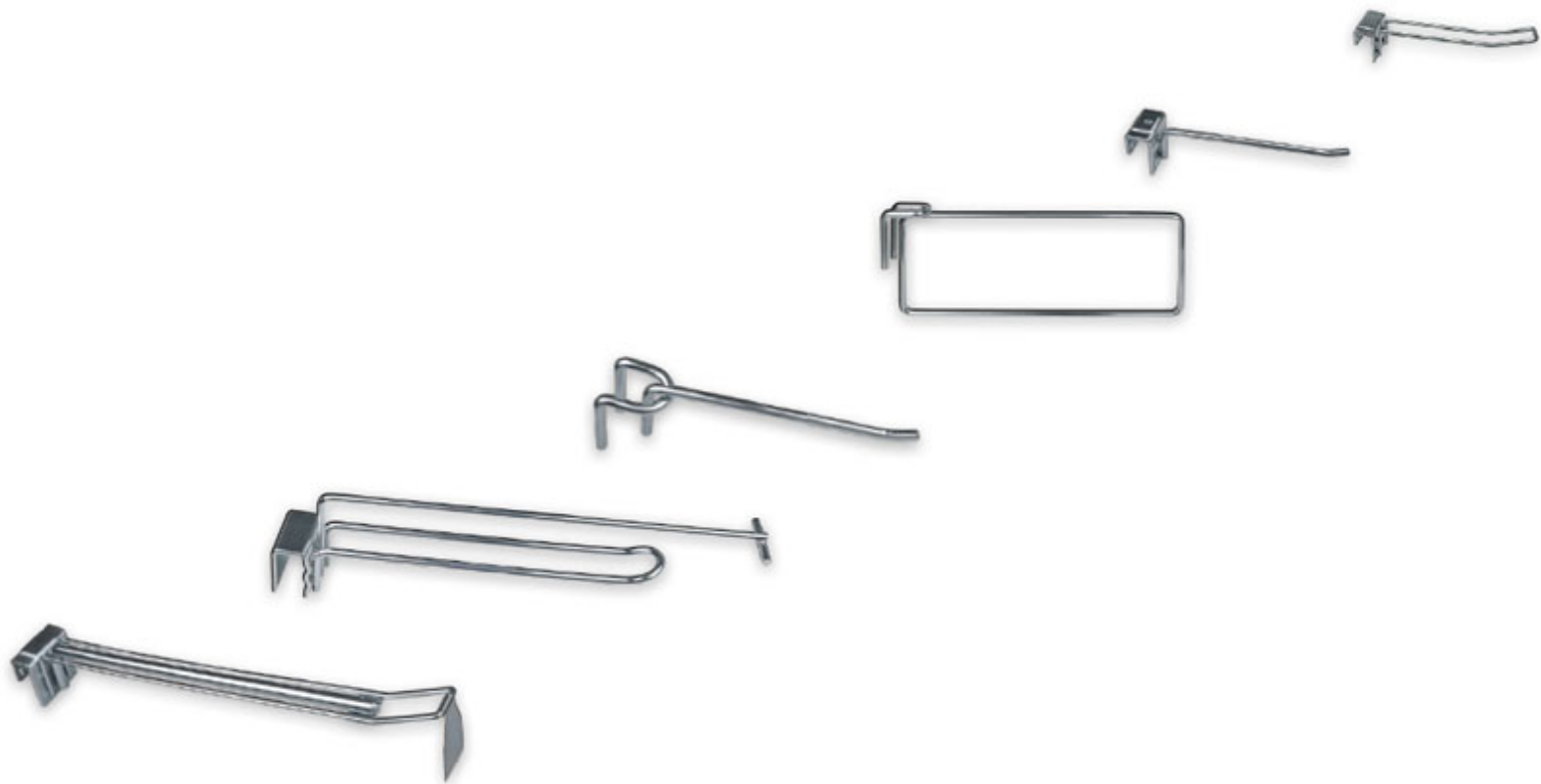



# 4





## Haken für Trageschiene

Hooks for bar systems  
Ganchos para sistema de barra  
Crochets pour barres

## Krallenhaken übergreifend für Trageschiene 20 mm verzinkt

Bar hook heavy type for rear support bar 20 mm zinc  
 Gancho de barra tipo pesado para barra 20 mm zincado  
 Crochet à poser sur barre de 20 mm zingué







				 mm	 mm		 kg
2491402010	20			8,0	200	50	19,4
2491403010	20			8,0	300	25	23,2
2491404010	20			8,0	400	25	27,0
2491405010	20			8,0	500	25	30,2

## Krallenhaken übergreifend für Trageschiene 20 mm verzinkt

Bar hook heavy type for rear support bar 20 mm zinc  
 Gancho de barra tipo pesado para barra 20 mm zincado  
 Crochet à poser sur barre de 20 mm zingué







				 mm	 mm		 kg
2491413010	20			10,0	300	25	32,0
2491414010	20			10,0	400	25	38,5
2491415010	20			10,0	500	25	45,0
2491423010	20			12,0	300	25	42,9
2491424010	20			12,0	400	25	51,9
2491425010	20			12,0	500	25	61,0

## Krallenhaken eingreifend für Trageschiene 20 mm verzinkt

Bar hook heavy type suitable for hanging into rear support bar 20 mm zinc  
 Gancho de barra tipo pesado para colgar en barra 20 mm zincado  
 Crochet à poser dans barre de 20 mm zingué



				 mm	 mm		 kg
2491402110	20			8,0	200	50	19,4
2491403110	20			8,0	300	25	23,4
2491404110	20			8,0	400	25	26,0
2491405110	20			8,0	500	25	29,8

## Krallenhaken eingreifend für Trageschiene 20 mm verzinkt

Bar hook heavy type suitable for hanging into rear support bar 20 mm zinc  
 Gancho de barra tipo pesado para colgar en barra 20 mm zincado  
 Crochet à poser dans barre de 20 mm zingué







				 mm	 mm		 kg
2491413110	20			10,0	300	25	32,0
2491414110	20			10,0	400	25	38,5
2491415110	20			10,0	500	25	44,7
2491423110*	20			12,0	300	25	42,9
2491424110*	20			12,0	400	25	51,9
2491425110*	20			12,0	500	25	61,0

\* Mindestbestellmenge 1000 Stück je Sorte / minimum order quantity 1000 pieces

\* Quantité minimale de commande: 1000 pièces / cantidad mínima por pedido: 1000 unidades

## Krallenhaken übergreifend mit Etikettenträger für Trageschiene 20 mm verzinkt

Bar hook heavy type with top label holder for rear support bar 20 mm zinc  
 Gancho de barra tipo pesado con soporte de etiqueta para barra 20 mm zincado  
 Crochet à poser sur barre de 20 mm avec bras porte-prix zingué





							
	20		mm		mm	50	kg
6091402010	20		8,0		200	50	21,0
6091403010	20		8,0		300	25	26,1
6091404010	20		8,0		400	25	31,2
6091405010	20		8,0		500	25	33,0



Die passenden Pendeltaschen finden Sie auf der Seite 35.

## Krallenhaken übergreifend mit Etikettenträger für Trageschiene 20 mm verzinkt

Bar hook heavy type with top label holder for rear support bar 20 mm zinc  
 Gancho de barra tipo pesado con soporte de etiqueta para barra 20 mm zincado  
 Crochet à poser sur barre de 20 mm avec bras porte-prix zingué







							
	20		mm		mm	25	kg
6091413010	20		10,0		300	25	32,0
6091414010	20		10,0		400	25	40,7
6091415010	20		10,0		500	25	42,0
6091424010	20		12,0		400	25	58,0
6091425010	20		12,0		500	25	66,6



Die passenden Pendeltaschen finden Sie auf der Seite 35.

## Trennbügel für gelochte Trageschiene 20 mm





Separator for rear support bar with holes 20 mm  
 Separador para colgar en la barra de apoyo trasera con agujeros 20 mm  
 Séparateur pour barre avec trous de 20 mm

							
	20		mm	mm		20	kg
5 4070 24	20		7,0	320	juraweiß	20	34,0
5 5043 24	20		7,0	420	juraweiß	20	38,2
5 5043 37	20		7,0	420	verzinkt	20	38,2



## Universal-Trennbügel für gelochte Trageschiene 20 mm verzinkt

Universal-separator for rear support bar with holes 20 mm zinc  
 Separador universal para colgar en barra de apoyo trasera con agujeros 20 mm zincado  
 Séparateur pour barre avec trous de 20 mm zingué

						
	20		mm	mm	5	kg
3005620310	20		8,0	200	5	24,0
3005620110	20		8,0	420	5	50,0







## Aufsteck-Einfachhaken für Trageschiene 15 mm verzinkt

Single hook for rear support bar 15 mm zinc

Gancho simple para barra 15 mm zincado

Crochet simple pour barre de 15 mm zingué



							
				mm	mm		kg
2440681510	15			4,8	150	50	11,2
2440682010	15			4,8	200	50	12,6
2440682510	15			4,8	250	50	14,0
2440683010	15			4,8	300	50	15,4
2440684010	15			4,8	400	50	16,6





## Aufsteck-Einfachhaken für Trageschiene 20 mm verzinkt

Single hook for rear support bar 20 mm zinc

Gancho simple para barra 20 mm zincado

Crochet simple pour barre de 20 mm zingué



							
				mm	mm		kg
2441681510	20			4,8	150	50	11,2
2441682010	20			4,8	200	50	12,6
2441682510	20			4,8	250	50	14,0
2441683010	20			4,8	300	50	15,4
2441684010	20			4,8	400	50	16,6





## Aufsteck-Einfachhaken für Trageschiene 15 mm verzinkt

Single hook for rear support bar 15 mm zinc

Gancho simple para barra 15 mm zincado

Crochet simple pour barre de 15 mm zingué



							
				mm	mm		kg
2440672510	15			8,0	250	50	19,4
2440673010	15			8,0	300	50	22,4
2440674010	15			8,0	400	50	27,1





## Aufsteck-Einfachhaken für Trageschiene 20 mm verzinkt

Single hook for rear support bar 20 mm zinc

Gancho simple para barra 20 mm zincado

Crochet simple pour barre de 20 mm zingué



							
				mm	mm		kg
2441672510	20			8,0	250	50	19,4
2441673010	20			8,0	300	50	22,4
2441674010	20			8,0	400	50	27,1

## Aufsteck-Einfachhaken mit Etikettenträger für Trageschiene 15 mm verzinkt

Single hook with top label holder for rear support bar 15 mm zinc  
 Gancho simple con soporte de etiqueta superior para barra 15 mm zincado  
 Crochet simple avec bras porte-prix pour barre de 15 mm zingué

6040681510	15			4,8	150	50	13,2
6040682010	15			4,8	200	50	14,6
6040682510	15			4,8	250	50	16,0
6040683010	15			4,8	300	50	17,4
6040684010	15			4,8	400	50	18,6



Die passenden Pendeltaschen finden Sie auf der Seite 35.

## Aufsteck-Einfachhaken mit Etikettenträger für Trageschiene 20 mm verzinkt

Single hook with top label holder for rear support bar 20 mm zinc  
 Gancho simple con soporte de etiqueta superior para barra 20 mm zincado  
 Crochet simple avec bras porte-prix pour barre de 20 mm zingué

6041681510	20			4,8	150	50	13,2
6041682010	20			4,8	200	50	14,6
6041682510	20			4,8	250	50	16,0
6041683010	20			4,8	300	50	17,4
6041684010	20			4,8	400	50	18,6



Die passenden Pendeltaschen finden Sie auf der Seite 35.

## Aufsteck-Einfachhaken mit Etikettenträger für Trageschiene 15 mm verzinkt

Single hook with top label holder for rear support bar 15 mm zinc  
 Gancho simple con soporte de etiqueta superior para barra 15 mm zincado  
 Crochet simple avec bras porte-prix pour barre de 15 mm zingué

6040672510	15			8,0	250	50	21,4
6040673010	15			8,0	300	50	24,4
6040674010	15			8,0	400	50	29,1



Die passenden Pendeltaschen finden Sie auf der Seite 35.

## Aufsteck-Einfachhaken mit Etikettenträger für Trageschiene 20 mm verzinkt

Single hook with top label holder for rear support bar 20 mm zinc  
 Gancho simple con soporte de etiqueta superior para barra 20 mm zincado  
 Crochet simple avec bras porte-prix pour barre de 20 mm zingué

6041672510	20			8,0	250	50	21,4
6041673010	20			8,0	300	50	24,4
6041674010	20			8,0	400	50	29,1







Die passenden Pendeltaschen finden Sie auf der Seite 35.

## Aufsteck-Einfachhaken für Trageschiene 20 mm verzinkt

Single hook suitable for rear support bar 20 mm zinc  
 Gancho simple para barra 20 mm de espesor zincado  
 Crochet simple emboîtable pour barre de 20 mm zingué







							
	mm			mm	mm		kg
5 3802 37	20			7,0	200	50	17,1
5 3804 37	20			7,0	250	50	19,4
5 3806 37	20			7,0	300	50	22,7
5 3808 37	20			10,0	400	50	37,8

## Aufsteck-Einfachhaken für gelochte Trageschiene 20 mm verzinkt

Single hook suitable for rear support bar 20 mm with holes zinc  
 Gancho simple para barra de apoyo de 20 mm de espesor trasera con agujeros zincado  
 Crochet simple emboîtable pour barre de 20 mm avec trous zingué







							
	mm			mm	mm		kg
5 1889 37	20			7,0	200	50	17,1
5 1890 37	20			7,0	250	50	19,4
5 1891 37	20			7,0	300	50	23,7
5 1439 37	20			10,0	400	50	37,5
5 1433 37	20			10,0	450	25	43,4

## Aufsteck-Einfachhaken mit Platte für gelochte Trageschiene 20 mm verzinkt

Single hook with end plate for rear support bar 20 mm with holes zinc  
 Gancho simple con placa final para barra 20 mm de espesor trasera con agujeros zincado  
 Crochet simple avec plaque ronde pour barre de 20 mm avec trous zingué







							
	mm			mm	mm		kg
5 1532 37	20			10,0	250	25	37,5
5 1579 37	20			10,0	400	25	43,4
5 1535 37	20			12,0	450	25	45,6

Artikel nur auf Anfrage erhältlich / only on request / uniquement sur demande / solamente a pedido

## Aufsteck-Doppelhaken für Trageschiene 20 mm verzinkt

Double hook for rear support bar 20 mm zinc  
 Gancho doble para barra 20 mm zincado  
 Crochet double emboîtable pour barre de 20 mm zingué



							
	mm			mm	mm		kg
5 3842 37	20			4,8	200	50	17,3
5 3844 37	20			4,8	300	50	20,3
5 3846 37	20			4,8	400	50	23,3

## Aufsteck-Doppelhaken für Trageschiene 15 mm verzinkt

Double hook for rear support bar 15 mm zinc  
Gancho doble para barra 15 mm zincado  
Crochet double pour barre de 15 mm zingué

	15			mm	mm		kg
2492111510	15			4,8	150	50	13,6
2492112010	15			4,8	200	50	15,4
2492112510	15			4,8	250	50	17,2
2492113010	15			4,8	300	50	19,0
2492114010	15			4,8	400	50	22,6



## Aufsteck-Doppelhaken für Trageschiene 20 mm verzinkt

Double hook for rear support bar 20 mm zinc  
Gancho doble para barra 20 mm zincado  
Crochet double pour barre de 20 mm zingué

	20			mm	mm		kg
2491111510	20			4,8	150	50	13,6
2491112010	20			4,8	200	50	15,4
2491112510	20			4,8	250	50	17,2
2491113010	20			4,8	300	50	19,0
2491114010	20			4,8	400	50	22,6



## Aufsteck-Doppelhaken mit Etikettenträger für Trageschiene 15 mm verzinkt

Double hook with top label holder for rear support bar 15 mm zinc  
Gancho doble con soporte de etiqueta superior para barra 15 mm zincado  
Crochet double avec bras porte-prix pour barre de 15 mm zingué

	15			mm	mm		kg
6092111510	15			4,8	150	50	15,6
6092112010	15			4,8	200	50	17,4
6092112510	15			4,8	250	50	19,2
6092113010	15			4,8	300	50	21,0
6092114010	15			4,8	400	50	24,6



Die passenden Pendeltaschen finden Sie auf der Seite 35.

## Aufsteck-Doppelhaken mit Etikettenträger für Trageschiene 20 mm verzinkt

Double hook with top label holder for rear support bar 20 mm zinc  
Gancho doble con soporte de etiqueta superior para barra 20 mm zincado  
Crochet double avec bras porte-prix pour barre de 20 mm zingué

	20			mm	mm		kg
6091111510	20			4,8	150	50	15,6
6091112010	20			4,8	200	50	17,4
6091112510	20			4,8	250	50	19,2
6091113010	20			4,8	300	50	21,0
6091114010	20			4,8	400	50	24,6



Die passenden Pendeltaschen finden Sie auf der Seite 35.





## Aufsteck-Einfachhaken für Trageschiene 15 mm verzinkt

Single hook for rear support bar 15 mm zinc

Gancho simple para barra 15 mm zincado

Crochet simple pour barre de 15 mm zingué



						
3892192010	15		4,8	200	50	12,6
3892193010	15		4,8	300	50	15,4
3892194010	15		4,8	400	50	16,6





## Aufsteck-Einfachhaken mit Etikettenträger für Trageschiene 15 mm verzinkt

Single hook with top label holder for rear support bar 15 mm zinc

Gancho simple con soporte de etiqueta superior para barra 15 mm zincado

Crochet simple avec bras porte-prix pour barre de 15 mm zingué



						
6092192010	15		4,8	200	50	14,6
6092193010	15		4,8	300	50	17,4
6092194010	15		4,8	400	50	18,6

Die passenden Pendeltaschen finden Sie auf der Seite 35.





## Aufsteck-Doppelhaken für Trageschiene 15 mm verzinkt

Double hook for rear support bar 15 mm zinc

Gancho doble para barra 15 mm zincado

Crochet double pour barre de 15 mm zingué



						
3892111510	15		4,8	150	50	13,6
3892112010	15		4,8	200	50	15,4
3892112510	15		4,8	250	50	17,2
3892113010	15		4,8	300	50	19,0
3892114010	15		4,8	400	50	22,6





## Aufsteck-Doppelhaken mit Etikettenträger für Trageschiene 15 mm verzinkt

Double hook with top label holder for rear support bar 15 mm zinc

Gancho doble con soporte de etiqueta superior para barra 15 mm zincado

Crochet double avec bras porte-prix pour barre de 15 mm zingué







						
6892111510	15		4,8	150	50	15,6
6892112010	15		4,8	200	50	17,4
6892112510	15		4,8	250	50	19,2
6892113010	15		4,8	300	50	21,0
6892114010	15		4,8	400	50	24,6

Die passenden Pendeltaschen finden Sie auf der Seite 35.



## Aufsteck-Schwerlasthaken für Trageschiene 20 mm verzinkt

Triple hook heavy type for rear support bar 20 mm zinc  
 Gancho triple tipo pesado para barra 20 mm zincado  
 Crochet triple emboîtable pour barre de 20 mm zingué





							
2492223010	20		4,0/10,0	300		25	46,0
2492224010	20		4,0/10,0	400		25	48,5
2492225010	20		4,0/10,0	500		25	51,0



Mindestbestellmenge 500 Stück je Sorte / minimum order quantity 500 pieces  
 Quantité minimale de commande: 500 pièces / cantidad mínima por pedido: 500 unidades

## Aufsteck-Schwerlasthaken mit Metallfahne für Trageschiene 20 mm verzinkt

Triple hook heavy with metal price flag for rear support bar 20 mm zinc  
 Gancho triple tipo pesado con bandera de precios metálica para barra 20 mm zincado  
 Crochet triple avec étiquette métallique porte-prix pour barre de 20 mm zingué





							
249222301028	20		4,0/10,0	300	28x28(35)	25	46,5
249222401028	20		4,0/10,0	400	28x28(35)	25	49,0
249222501028	20		4,0/10,0	500	28x28(35)	25	54,5



Mindestbestellmenge 500 Stück je Sorte / minimum order quantity 500 pieces  
 Quantité minimale de commande: 500 pièces / cantidad mínima por pedido: 500 unidades

## Aufsteck-Schwerlasthaken mit Metallfahne für Trageschiene 20 mm verzinkt

Triple hook heavy type with metal price flag for rear support bar 20 mm zinc  
 Gancho triple tipo pesado con bandera de precios metálica para barra 20 mm zincado  
 Crochet triple avec étiquette métallique porte-prix pour barre de 20 mm zingué





							
249222301052	20		4,0/10,0	300	28x30(52)	25	46,5
249222401052	20		4,0/10,0	400	28x30(52)	25	49,0
249222501052	20		4,0/10,0	500	28x30(52)	25	54,5



Mindestbestellmenge 500 Stück je Sorte / minimum order quantity 500 pieces  
 Quantité minimale de commande: 500 pièces / cantidad mínima por pedido: 500 unidades

## Aufsteck-Schwerlasthaken mit Etikettenträger für Trageschiene 20 mm verzinkt

Triple hook heavy type with top label holder suitable for rear support bar 20 mm zinc  
 Gancho triple tipo pesado con soporte de etiqueta superior para barra 20 mm zincado  
 Crochet triple avec bras porte-prix pour barre de 20 mm zingué

							
6092223010	20		4,0/10,0	300		25	52,5
6092224010	20		4,0/10,0	400		25	58,7
6092225010	20		4,0/10,0	500		25	64,9







Mindestbestellmenge 500 Stück je Sorte / minimum order quantity 500 pieces  
 Quantité minimale de commande: 500 pièces / cantidad mínima por pedido: 500 unidades  
 Die passenden Pendeltaschen finden Sie auf der Seite 35.

## Trageschiene aus Vierkantrohr 50 x 20 mm gelocht

Support bar made of square tube 50 x 20 mm with holes  
 Barra de carga, tubo cuadrado 50 x 20 mm con agujeros  
 Barre de charge en tube carré 50 x 20 mm avec trous







				 mm			 kg
8050040665	20			665	RAL 7035	1	111,0
8050041000	20			1000	RAL 7035	1	145,0
8050041250	20			1250	RAL 7035	1	181,0
8050050665	20			665	RAL 9006	1	111,0
8050051000	20			1000	RAL 9006	1	145,0
8050051250	20			1250	RAL 9006	1	181,0
8050060665	20			665	RAL 9001	1	111,0
8050061000	20			1000	RAL 9001	1	145,0
8050061250	20			1250	RAL 9001	1	181,0

## Trageschiene aus Vierkantrohr 50 x 20 mm ungelocht

Support bar made of square tube 50 x 20 mm without holes  
 Barra de carga, tubo cuadrado 50 x 20 mm sin perforaciones  
 Barre de charge en tube carré 50 x 20 mm sans trous



				 mm			 kg
1250251000	20			1000	RAL 9010	1	150,0
1250251250	20			1250	RAL 9010	1	185,0

# HOHAGE

Wir biegen Lösungen

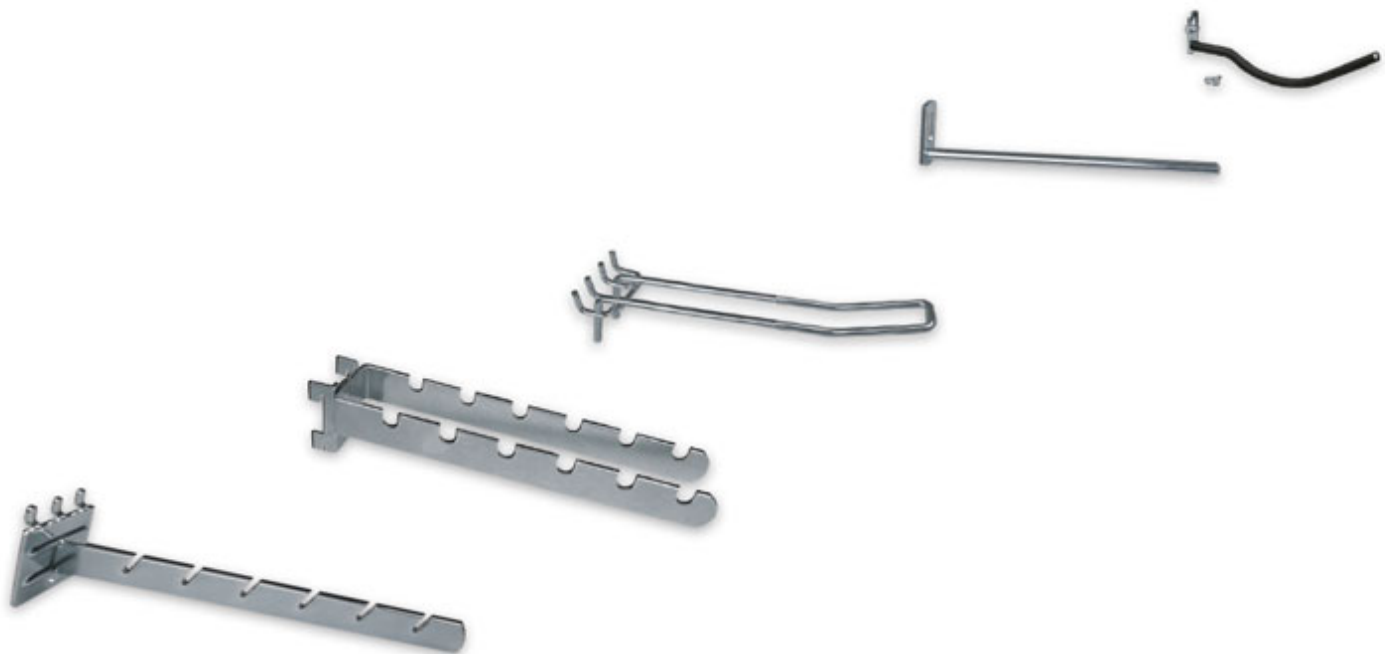

# HOHAGE

---

Wir biegen Lösungen

5

## Sonderhaken Werkzeuge

Special hooks for tools

Ganchos especiales para herramientas

Crochets spéciaux pour outils

## Einfach-Kellenhalter mit Einhängelplatte verzinkt

Single trowel holder with plate zinc

Soporte simple paletas con placa zincado

Support simple pour truelle, avec platine zingué



15	mm	mm	mm	mm			kg
2493410110	30		20x3	235		25	13,8

## Einfach-Kellenhalter mit Einhängelplatte und Fahnenhalter verzinkt

Single trowel holder with plate and price flag holder zinc

Soporte simple paletas con placa y soporte portaprecios zincado

Support simple pour truelle, platine, avec porte-étiquette zingué



15	mm	mm	mm	mm			kg
2493410110FH	30		20x3	235		25	14,0

## Einfach-Kellenhalter mit Einhängelplatte, Fahnenhalter und Metallfahne verzinkt

Single trowel holder with plate and metal price flag zinc

Soporte simple paletas con placa y soporte portaprecios zincado

Support simple pour truelle, platine, avec porte-étiquette et étiquette métallique attachée zingué



15	mm	mm	mm	mm	a b mm c d mm e f mm		kg
249341011028	30		20x3	235	28x28(35)	25	14,6

## Einfach-Kellenhalter mit Einhängelplatte, Fahnenhalter und Metallfahne verzinkt

Single trowel holder with plate and metal price flag zinc

Soporte simple paletas con placa y soporte portaprecios zincado







Support simple pour truelle, platine, avec porte-étiquette et étiquette métallique attachée zingué

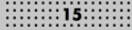

15	mm	mm	mm	mm	a b mm c d mm e f mm		kg
249341011052	30		20x3	235	28x30(52)	25	14,6

## Doppel-Kellenhalter mit Einhängplatte verzinkt







Double trowel holder with plate zinc  
Soporte doble paletas con placa zincado  
Support double pour truelle, avec platine zingué

					
2493420110	30	20x3	235	25	23,7



## Doppel-Kellenhalter mit Einhängplatte und Fahnenhalter verzinkt







Double trowel holder with plate and price flag holder zinc  
Soporte doble paletas con placa y soporte portaprecios zincado  
Support double pour truelle, platine, avec porte-étiquette zingué

					
2493420110FH	30	20x3	235	25	24,0



## Doppel-Kellenhalter mit Einhängplatte, Fahnenhalter und Metallfahne verzinkt







Double trowel holder with plate and holder with metal price flag zinc  
Soporte doble paletas con placa y soporte portaprecios zincado  
Support double pour truelle, platine, avec porte-étiquette et étiquette métallique attachée zingué

						
249342011028	30	20x3	235	28x28(35)	25	25,1

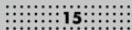

## Doppel-Kellenhalter mit Einhängplatte, Fahnenhalter und Metallfahne verzinkt

Double trowel holder with plate and holder with metal price flag zinc  
Soporte doble paletas con placa y soporte portaprecios zincado  
Support double pour truelle, platine, avec porte-étiquette et étiquette métallique attachée zingué

						
249342011052	30	20x3	235	28x30(52)	25	25,1



## Doppelhaken für Rückwand mit Schlüssellochung verzinkt

Suspension hook for back panel with key holes zinc

Gancho de suspensión para paneles traseros perforados llave zincado

Crochet double pour fond à perforation clés zingué



Part Number	mm	mm	mm	kg
3 6432 37	4,8	200	50	13,8
3 6434 37	4,8	300	50	15,9

Artikel nur auf Anfrage erhältlich / only on request / uniquement sur demande / solamente a pedido

## Gerätehalter für Rückwand mit Schlüssellochung verzinkt

Tool holder for back panel with key holes zinc

Soporte herramienta para paneles traseros perforados llave zincado

Support outils pour fond à perforation clés zingué



Part Number	mm	mm	mm	kg
3 6754 37	300	60	10	86,1

Artikel nur auf Anfrage erhältlich / only on request / uniquement sur demande / solamente a pedido

## Displayhalter 500 - 1000 mm teleskopierbar verzinkt

Display holder telescopic 500 - 1000 mm zinc

Soporte expositor telescopico 500 - 1000 mm zincado

Porte-display extensible 500 - 1000 mm zingué



Part Number	mm	mm	mm	kg
3040550110	12,0/7,0	500-1000	1	23,6
3040540110	12,0/7,0	500-1000	1	23,6

Mindestbestellmenge 500 Stück je Sorte / minimum order quantity 500 pieces  
Quantité minimale de commande: 500 pièces / cantidad mínima por pedido: 500 unidades

## Werkzeughalter verzinkt

Hammer holder zinc

Soporte martillo zincado

Porte-marteau zingué



Part Number	mm	mm	mm	mm	mm	kg	
3040300510	-	-	45	6,0	220	10	51,2
-	3040300110	20	-	6,0	220	10	63,6

Mindestbestellmenge 500 Stück je Sorte / minimum order quantity 500 pieces  
Quantité minimale de commande: 500 pièces / cantidad mínima por pedido: 500 unidades

## Gerätehalter für Trageschiene 20 mm, Breite 60 mm verzinkt

Tool holder for rear support bar 20 mm, width 60 mm zinc

Soporte herramienta para barra de carga trasera 20 mm, ancho 60 mm zincado

Support outils pour barre de charge 20 mm, largeur 60 mm zingué

					
5 3686 37	20	300	60	10	51,2
5 3685 37*	20	480	60	10	63,6

\* Mindestbestellmenge 500 Stück / minimum order quantity 500 pieces  
 \* Quantité minimale de commande: 500 pièces / cantidad mínima por pedido: 500 unidades







## Spatenhalter gewellt für 8 Spaten mit Schild 60 x 30 mm für Trageschiene 20 mm verzinkt

Corrugated holder for spades, suitable for 8 spades, with plate 60 x 30 mm for rear support bar 20 mm zinc

Soporte corrugado para palas, apto para 8 palas con placa 60 x 30 mm zincado

Porte-bêche ondulée pour 8 bêches, avec plaque 60 x 30 mm zingué

					
3010470310	20	10,0	400	1	70,6





## Werkzeughalter mit Gummischlauch inklusive Schraube und Spezialmutter verzinkt

Holder with rubber for tools with screw and special nut zinc  
 Soporte herramienta con goma para taladro, con tornillo y tuerca especial zincado  
 Porte-outil et perceuse, avec enrobage en caoutchouc, avec vis et écrou spécial zingué



Part Number	mm	mm	kg	
3 6420 37	9,0	180	50	10,7

## Schraube und Spezialmutter für Rückwand mit Schlüssellochung verzinkt

Screw with special nut for back panel with key holes zinc  
 Tornillo con tuerca especial para el panel trasero con perforado llave zincado  
 Vis et écrous spéciaux pour fond à perforation clés zingués



Part Number	kg	
6 3905 37 V	25	0,6

## Werkzeughalter inklusive Schraube und Spezialmutter verzinkt

Holder for tools with screw and special nut zinc  
 Soporte herramienta, con tornillo y tuerca especial zincado  
 Porte-outil et perceuse, avec vis et écrou spécial zingué



Part Number	mm	mm	kg	
3 6400 37*	7,0	90	50	4,1
3 6405 37	9,0	90	50	4,7

\* ohne Gummischlauch / without rubber / sin goma / sans enrobage en caoutchouc

## Displayhalter zum Anschrauben mit L-Profil verzinkt

Display holder to screw on, with L-profile zinc  
 Soporte expositor para atornillar, con perfil "L" zincado  
 Porte-display à visser avec profil "L" zingué



Part Number	mm	mm	kg	
4000862010	7,0	200	50	4,2
4000863010	7,0	300	50	7,2
4000864010	7,0	400	50	10,2

Mindestbestellmenge 500 Stück je Sorte / minimum order quantity 500 pieces  
 Quantité minimale de commande: 500 pièces / cantidad mínima por pedido: 500 unidades

## Dornhaken mit Gummischlauch zum Anschrauben verzinkt

Tool holder with rubber to screw on zinc  
 Portaherramientas con goma para atornillar zincado  
 Broche à visser, avec enrobage en caoutchouc zinguée

15:				mm	mm		kg
9734-090100A				9,0/7,0	100	50	4,8
9734-090200A				9,0/7,0	200	50	7,6
9734-090300A				9,0/7,0	300	50	10,2



## Dornhaken mit Gummischlauch inklusive Schraube und Spezialmutter verzinkt

Tool holder with rubber, with screw and special nut zinc  
 Soporte herramienta con goma, con tornillo y tuerca especial zincado  
 Broche avec enrobage en caoutchouc, avec vis et écrou spécial zinguée

				mm	mm		kg
3 6330 37				9,0/7,0	100	50	3,8
3 6332 37				9,0/7,0	200	50	7,6
3 6334 37				9,0/7,0	300	50	11,4



## Dornhaken zum Anschrauben verzinkt

Tool holder to screw on zinc  
 Soporte herramienta para atornillar zincado  
 Broche à visser zinguée

				mm	mm		kg
9738-040040A				4,0	40	50	1,7
9738-040060A				4,0	60	50	1,8
9738-040080A				4,0	80	50	1,9
9738-040120A				4,0	120	50	2,2
9738-040170A				4,0	170	50	2,7
9732-070100A				7,0	100	50	4,0
9732-070200A				7,0	200	50	7,1
9732-070300A				7,0	300	50	10,2



## Dornhaken inklusive Schraube und Spezialmutter verzinkt

Tool holder with screw and special nut zinc  
 Soporte herramienta con tornillo y tuerca especial zincado  
 Broche avec vis et écrou spécial zinguée

				mm	mm		kg
3 6300 37				4,0	40	50	1,0
3 6302 37				4,0	60	50	1,5
3 6304 37				4,0	80	50	2,0
3 6308 37				4,0	120	50	3,0
3 6313 37				4,0	170	50	4,3
3 6320 37				7,0	100	50	2,4
3 6322 37				7,0	200	50	4,7
3 6324 37				7,0	300	50	7,1



## Doppelhaken mit Einhängeplatte verzinkt

Double hook with plate zinc  
Gancho doble con placa zincado  
Crochet double avec platine zingué



15	25	mm	mm	mm			
2492591610	2492791610*	30/25	4,8	160		100	5,8
2492592010	2492792010*	30/25	4,8	200		100	9,6
2492593010	2492793010*	30/25	4,8	300		100	13,4

\* Artikel nur auf Anfrage erhältlich / only on request / uniquement sur demande / solamente a pedido

## Einfachhaken mit Einhängeplatte verzinkt

Single hook with plate zinc  
Gancho simple con placa zincado  
Crochet simple avec platine zingué



15	25	mm	mm	mm			
9315-034050A	-	15	3,4	50		50	1,0

## Schlüsselhaken mit Einhängeplatte verzinkt

Special key hook with plate zinc  
Gancho especial llave con placa zincado  
Crochet spécial de clés avec platine zingué



15	25	mm	mm	mm			
9316-034065A	-	15	3,4	65		50	1,2

Mindestbestellmenge 1000 Stück / minimum order quantity 1000 pieces  
Quantité minimale de commande: 1000 pièces / cantidad mínima por pedido: 1000 unidades

## Spatenhalter mit 6 Kerben und Klappverschluss verzinkt

Fast entry spade holder with 6 notches zinc  
Soporte acceso rapido con 6 muescas zincado  
Porte-bêche avec 6 rainures, et arrêt de sécurité zinguée



15		mm	mm	mm			
7501003210		75		320	105	10	76,4

Mindestbestellmenge 500 Stück / minimum order quantity 500 pieces  
Quantité minimale de commande: 500 pièces / cantidad mínima por pedido: 500 unidades

## Kellenhalter für Lochwand mit Fahnenhalter und Kunststoff-Fahne 40 mm verzinkt

Trowel holder for back panel with holes, with price flag holder and plastic flag 40 mm zinc

Soporte para paneles traseros perforados, con plástico portaprecios 40 mm zincado

Support truelle pour fond perforé, avec porte-étiquette et étiquette plastique 40 mm attachée zingué

15:		 mm	 mm	 mm		 kg
4502003210		45	320	40	25	66,9
7502003210		75	320	70	10	69,8

Mindestbestellmenge 500 Stück je Sorte / minimum order quantity 500 pieces  
Quantité minimale de commande: 500 pièces / cantidad mínima por pedido: 500 unidades







## Halter schwenkbar zur Einhängung in 2 gelochte Trageschienen 20 mm verzinkt

Pivotable holder for hanging into 2 rear support bars with holes 20 mm zinc

Soporte pivotable, con 2 varillas de enganche, para soporte barras traseras de 20 mm perforadas zincado

Support pivotant à accrocher dans 2 barres de charge perforées 20 mm zingué

	 mm	 mm	 mm		 kg
5 1339 37	20	7,0	550	50	40,6
5 1340 37	20	7,0	750	50	52,3

Artikel nur auf Anfrage erhältlich / only on request / uniquement sur demande / solamente a pedido



# HOHAGE

Wir biegen Lösungen

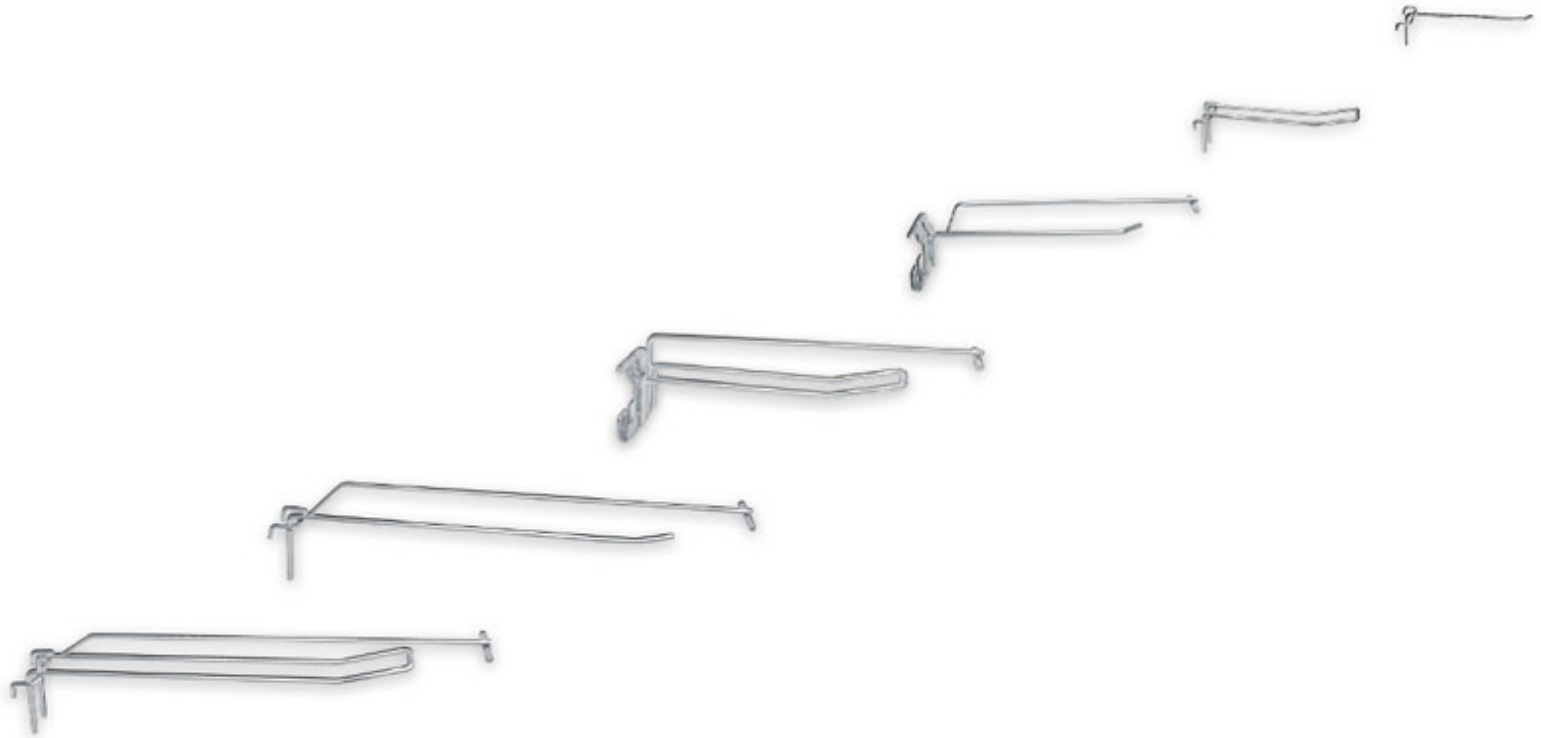

## **Gitterwandhaken**

Hooks for grid wall  
Ganchos para rejillas  
Crochets pour fond grillagé





## Gitterwand-Einfachhaken mit Brücke verzinkt

Single hook for grid wall with wire bridge zinc

Gancho simple para rejilla zincado

Crochet simple pour fond grillagé zingué



			 mm		 mm		 kg
2497541010			4,8	50	100	50	3,8
2497542010			4,8	50	200	50	5,0
2497543010			4,8	50	300	50	6,2

Mindestbestellmenge 500 Stück je Sorte / minimum order quantity 500 pieces  
Quantité minimale de commande: 500 pièces / cantidad mínima por pedido: 500 unidades

## Gitterwand-Einfachhaken mit Brücke und Etikettenträger verzinkt

Single hook for grid wall with wire bridge and top label holder zinc

Gancho simple para rejilla con soporte de etiqueta superior zincado

Crochet simple pour fond grillagé avec bras porte-prix zingué



			 mm		 mm		 kg
6092481010			4,8	50	100	50	4,7
6092482010			4,8	50	200	50	6,7
6092483010			4,8	50	300	50	8,7

Mindestbestellmenge 500 Stück je Sorte / minimum order quantity 500 pieces  
Quantité minimale de commande: 500 pièces / cantidad mínima por pedido: 500 unidades  
Die passenden Pendeltaschen finden Sie auf der Seite 35.

## Gitterwand-Einfachhaken mit Brücke verzinkt

Single hook for grid wall with wire bridge zinc

Gancho simple para rejilla zincado

Crochet simple pour fond grillagé zingué



			 mm		 mm		 kg
2497550510			4,8	40+50	50	50	4,2
2497551010			4,8	40+50	100	50	4,8
2497551510			4,8	40+50	150	50	6,9
2497552010			4,8	40+50	200	50	9,6

Mindestbestellmenge 500 Stück je Sorte / minimum order quantity 500 pieces  
Quantité minimale de commande: 500 pièces / cantidad mínima por pedido: 500 unidades

## Gitterwand-Einfachhaken mit Brücke und Etikettenträger verzinkt

Single hook for grid wall with wire bridge and top label holder zinc

Gancho simple para rejilla con soporte de etiqueta superior zincado

Crochet simple pour fond grillagé avec bras porte-prix zingué









			 mm		 mm		 kg
6097640510			4,0	80+90	50	50	4,5
6097641010			4,0	80+90	100	50	5,5
6097641510			4,0	80+90	150	50	7,8
6097642010			4,0	80+90	200	50	9,5

Mindestbestellmenge 500 Stück je Sorte / minimum order quantity 500 pieces  
Quantité minimale de commande: 500 pièces / cantidad mínima por pedido: 500 unidades  
Die passenden Pendeltaschen finden Sie auf der Seite 35.

## Gitterwand-Einfachhaken mit Lasche verzinkt

Single hook for grid wall with suspension plate zinc  
 Gancho simple para rejilla con placa colgante zincado  
 Crochet simple pour fond grillagé zingué







						
		mm	mm	mm		kg
2510611010		6,0	50	100	50	6,2
2510611510		6,0	50	150	50	9,3
2510612010		6,0	50	200	50	12,2
2510612510		6,0	50	250	50	15,1

Mindestbestellmenge 500 Stück je Sorte / minimum order quantity 500 pieces  
 Quantité minimale de commande: 500 pièces / cantidad mínima por pedido: 500 unidades



## Gitterwand-Einfachhaken mit Lasche für Kreuzbehang verzinkt

Single hook for grid wall with suspension plate for cross mesh zinc  
 Gancho simple para rejilla con placa colgante para malla metálica cruzada zincado  
 Crochet simple pour fond grillagé zingué

						
		mm	mm	mm		kg
2510421010		4,8	50	100	50	7,5
2510421510		4,8	50	150	50	11,3
2510422010		4,8	50	200	50	15,1
2510422510		4,8	50	250	50	19,2
2510423010		4,8	50	300	50	24,1

Mindestbestellmenge 500 Stück je Sorte / minimum order quantity 500 pieces  
 Quantité minimale de commande: 500 pièces / cantidad mínima por pedido: 500 unidades



## Gitterwand-Einfachhaken mit Lasche für Kreuzbehang und Etikettenträger verzinkt

Single hook for grid wall with suspension plate for cross mesh with top label holder zinc  
 Gancho simple para rejilla con placa colgante para malla metálica cruzada con soporte de etiqueta superior zincado  
 Crochet simple pour fond grillagé avec bras porte-prix zingué

						
		mm	mm	mm		kg
2510420110		4,8	50	100	50	8,0
2510420510		4,8	50	150	50	9,9
2510422110		4,8	50	200	50	11,8
2510422410		4,8	50	250	50	13,7
2510423110		4,8	50	300	50	15,6

Mindestbestellmenge 500 Stück je Sorte / minimum order quantity 500 pieces  
 Quantité minimale de commande: 500 pièces / cantidad mínima por pedido: 500 unidades  
 Die passenden Pendeltaschen finden Sie auf der Seite 35.











## Gitterwand-Doppelhaken mit Brücke verzinkt

Double hook for grid wall with wire bridge zinc

Gancho doble para rejilla con unión de alambre doblado hacia arriba zincado

Crochet double pour fond grillagé zingué



							
			mm	mm	mm		kg
2520121042			4,8	50	100	50	6,3
2520121542			4,8	50	150	50	7,4
2520120342			4,8	50	200	50	8,5
2520120142			4,8	50	300	50	10,3
2520120542			4,8	50	400	50	12,5







## Gitterwand-Doppelhaken mit Brücke und Etikettenträger verzinkt

Double hook for grid wall with wire bridge and top label holder zinc

Gancho doble para rejilla con unión de alambre doblado hacia arriba con soporte de etiqueta superior zincado

Crochet double pour fond grillagé avec bras porte-prix zingué



							
			mm	mm	mm		kg
6020121042			4,8	50	100	50	5,8
6020121542			4,8	50	150	50	7,8
6020122042			4,8	50	200	50	11,7
6020123042			4,8	50	300	50	15,6
6020124042			4,8	50	400	50	19,6

Mindestbestellmenge 500 Stück je Sorte / minimum order quantity 500 pieces

Quantité minimale de commande: 500 pièces / cantidad mínima por pedido: 500 unidades

Die passenden Pendeltaschen finden Sie auf der Seite 35.







## Gitterwand-Doppelhaken mit Brücke verzinkt

Double hook for grid wall with wire bridge zinc

Gancho doble para rejilla con pie de alambre doblado hacia arriba zincado

Crochet double pour fond grillagé zingué



							
			mm	mm	mm		kg
2497580510			4,8	50	50	50	5,8
2497581010			4,8	50	100	50	7,2
2497582010			4,8	50	200	50	10,0

Artikel nur auf Anfrage erhältlich / only on request / uniquement sur demande / solamente a pedido







## Gitterwand-Doppelhaken mit Brücke und Etikettenträger verzinkt

Double hook for grid wall with wire bridge and top label holder zinc

Gancho doble para rejilla con pie de alambre doblado hacia arriba con soporte de etiqueta superior zincado

Crochet double pour fond grillagé avec bras porte-prix zingué









							
			mm	mm	mm		kg
6097650510			4,0	80+90	50	50	7,3
6097651010			4,0	80+90	100	50	8,7
6097651510*			4,0	80+90	150	50	10,1
6097652010*			4,0	80+90	200	50	11,5

Artikel nur auf Anfrage erhältlich / only on request / uniquement sur demande / solamente a pedido

Die passenden Pendeltaschen finden Sie auf der Seite 35.

## Gitterwand-Doppelhaken mit Lasche verzinkt

Double hook for grid wall with suspension plate zinc  
 Gancho doble para rejilla con placa colgante zincado  
 Crochet double pour fond grillagé zingué







						
		mm	mm	mm	kg	kg
2510551010		4,0	50	100	50	8,5
2510551510		4,0	50	150	50	9,0
2510552010		4,0	50	200	50	10,0

Artikel nur auf Anfrage erhältlich / only on request / uniquement sur demande / solamente a pedido



## Gitterwand-Doppelhaken mit Lasche für Kreuzbehang verzinkt

Double hook for grid wall with suspension plate for cross mesh zinc  
 Gancho doble para rejilla con placa colgante para malla metálica cruzada zincado  
 Crochet double pour fond grillagé zingué







						
		mm	mm	mm	kg	kg
2510491510		4,8	50	150	50	11,0
2510492010		4,8	50	200	50	12,4
2510492510		4,8	50	250	50	13,8
2510493010		4,8	50	300	50	16,6

Artikel nur auf Anfrage erhältlich / only on request / uniquement sur demande / solamente a pedido



## Gitterwand-Doppelhaken mit Lasche für Kreuzbehang und Etikettenträger verzinkt

Double hook with suspension plate for cross mesh with top label holder zinc  
 Gancho doble con placa colgante para malla metálica cruzada con tope etiqueta zincado  
 Crochet double pour fond grillagé avec bras porte-prix zingué

						
		mm	mm	mm	kg	kg
2510431510		4,8	50	150	50	11,8
2510432110		4,8	50	200	50	15,8
2510432510		4,8	50	250	50	19,7
2510433110		4,8	50	300	50	23,7

Artikel nur auf Anfrage erhältlich / only on request / uniquement sur demande / solamente a pedido  
 Die passenden Pendeltaschen finden Sie auf der Seite 35.



# HOHAGE

Wir biegen Lösungen



# 7

## Lamellenwandhaken

Slatwall hooks

Ganchos para panel de lamas

Crochets pour fond lame





## Lamellenwand-Einfachhaken verzinkt

Single hook for slatwall zinc

Gancho simple para panel de lamas zincado

Crochet simple pour fond lame zingué



				 mm	 mm		 kg
2492941010				4,8	100	50	4,9
2492941510				4,8	150	50	5,6
2492942010				4,8	200	50	6,3
2492942510				4,8	250	50	7,0
2492943010				4,8	300	50	7,7
2492944010				4,8	400	50	8,4





## Lamellenwand-Doppelhaken verzinkt

Double hook for slatwall zinc

Gancho doble para panel de lamas zincado

Crochet double pour fond lame zingué



				 mm	 mm		 kg
2492541010				4,8	100	50	5,7
2492541510				4,8	150	50	6,4
2492542010				4,8	200	50	7,1
2492542510				4,8	250	50	7,8
2492543010				4,8	300	50	8,5
2492544010				4,8	400	50	10,1





## Lamellenwand-Einfachhaken mit Etikettenträger verzinkt

Single hook for slatwall with top label holder zinc

Gancho simple con tope etiqueta para panel de lamas zincado

Crochet simple avec bras porte-prix pour fond lame zingué



				 mm	 mm		 kg
6092421010				4,8	100	50	8,9
6092421510				4,8	150	50	9,6
6092422010				4,8	200	50	10,3
6092422510				4,8	250	50	11,0
6092423010				4,8	300	50	11,7

Die passenden Pendeltaschen finden Sie auf der Seite 35.





## Lamellenwand-Doppelhaken mit Etikettenträger verzinkt

Double hook for slatwall with top label holder zinc

Gancho doble con tope etiqueta para panel de lamas zincado

Crochet double avec bras porte-prix pour fond lame zingué



				 mm	 mm		 kg
6092541010				4,8	100	50	9,7
6092541510				4,8	150	50	10,4
6092542010				4,8	200	50	11,1
6092542510				4,8	250	50	11,8
6092543010				4,8	300	50	12,5





Die passenden Pendeltaschen finden Sie auf der Seite 35.

## Lamellenwand-Abhängearm gerade aus Ovalrohr, mit Begrenzungskugel verchromt

Straight front arm with ball, for slatwall, made of oval bar chrome finish

Brazo recto con top para panel de lamas, barra oval cromado

Bras droit avec bille pour fond lame chromé

							
8033823005			300		30x15	1	34,2
8033824005			400		30x15	1	45,6

Artikel nur auf Anfrage erhältlich / only on request / uniquement sur demande / solamente a pedido







## Lamellenwand-Abhängearm schräg aus Ovalrohr, mit Stiften verchromt

Sloping front arm, for slatwall, made of oval bar chrome finish

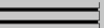
Brazo inclinado para panel de lamas, barra oval cromado

Bras incliné pour fond lame chromé

							
8033772305*			230		30x15	1	30,5
8033773805**			380		30x15	1	50,4

\* mit 6 Stiften / pins /  
\*\*mit 10 Stiften / pins /  
Artikel nur auf Anfrage erhältlich / only on request / uniquement sur demande / solamente a pedido







## Lamellenwand-Abhängearm schräg aus Ovalrohr, mit Haken verchromt

Sloping front arm with hooks, for slatwall, made of oval bar chrome finish

Brazo inclinado con ganchos para panel de lamas, barra oval cromado

Bras incliné avec crochets pour fond lame chromé

							
8033782005*			200		30x15	1	40,0
8033783005**			300		30x15	1	60,0

\* mit 3 Haken / hooks / ganchos / crochets  
\*\*mit 5 Haken / hooks / ganchos / crochets  
Artikel nur auf Anfrage erhältlich / only on request / uniquement sur demande / solamente a pedido









## Lamellenwand-Stufenabhängearm aus Ovalrohr, mit Kugeln verchromt

Stepped front arm with balls, for slatwall, made of oval bar chrome finish

Brazo escalera con botones para panel de lamas, barra oval cromado

Bras à niveaux avec billes pour fond lame chromé

							
8033793505			350	200	30x15	1	55,3

Artikel nur auf Anfrage erhältlich / only on request / uniquement sur demande / solamente a pedido







## Lamellenwand-Ballhalter verchromt

Ball holder for slatwall chrome finish

Soporte balón para panel de lamas cromado

Support pour ballons chromé



							
8057821605				6,0	150	1	21,5

Artikel nur auf Anfrage erhältlich / only on request / uniquement sur demande / solamente a pedido





## Lamellenwand-Einfachhaken verchromt

Single hook for slatwall chrome finish

Gancho simple para panel de lamas cromado

Crochet simple pour fond lame chromé



							
8092940805				5,0	80	50	4,6
8092941505				5,0	150	50	5,6
8092942505				5,0	250	50	7,0





## Lamellenwand-Doppelhaken verchromt

Double hook for slatwall chrome finish

Gancho doble para panel de lamas cromado

Crochet double pour fond lame chromé



							
8092541505				3,4	150	50	6,4
8092542005				5,0	200	50	7,1
8092542505				5,0	250	50	7,8





## Lamellenwand-Doppelhaken mit Etikettenträger verchromt

Double hook for slatwall with top label holder chrome finish

Gancho doble con tope etiqueta para panel de lamas cromado

Crochet double avec bras porte-prix pour fond lame chromé



							
8192542005				5,0	200	50	11,1
8192542505				5,0	250	50	11,8
8192543005				5,0	300	50	12,5

Die passenden Pendeltaschen finden Sie auf der Seite 35.

# HOHAGE

Wir biegen Lösungen

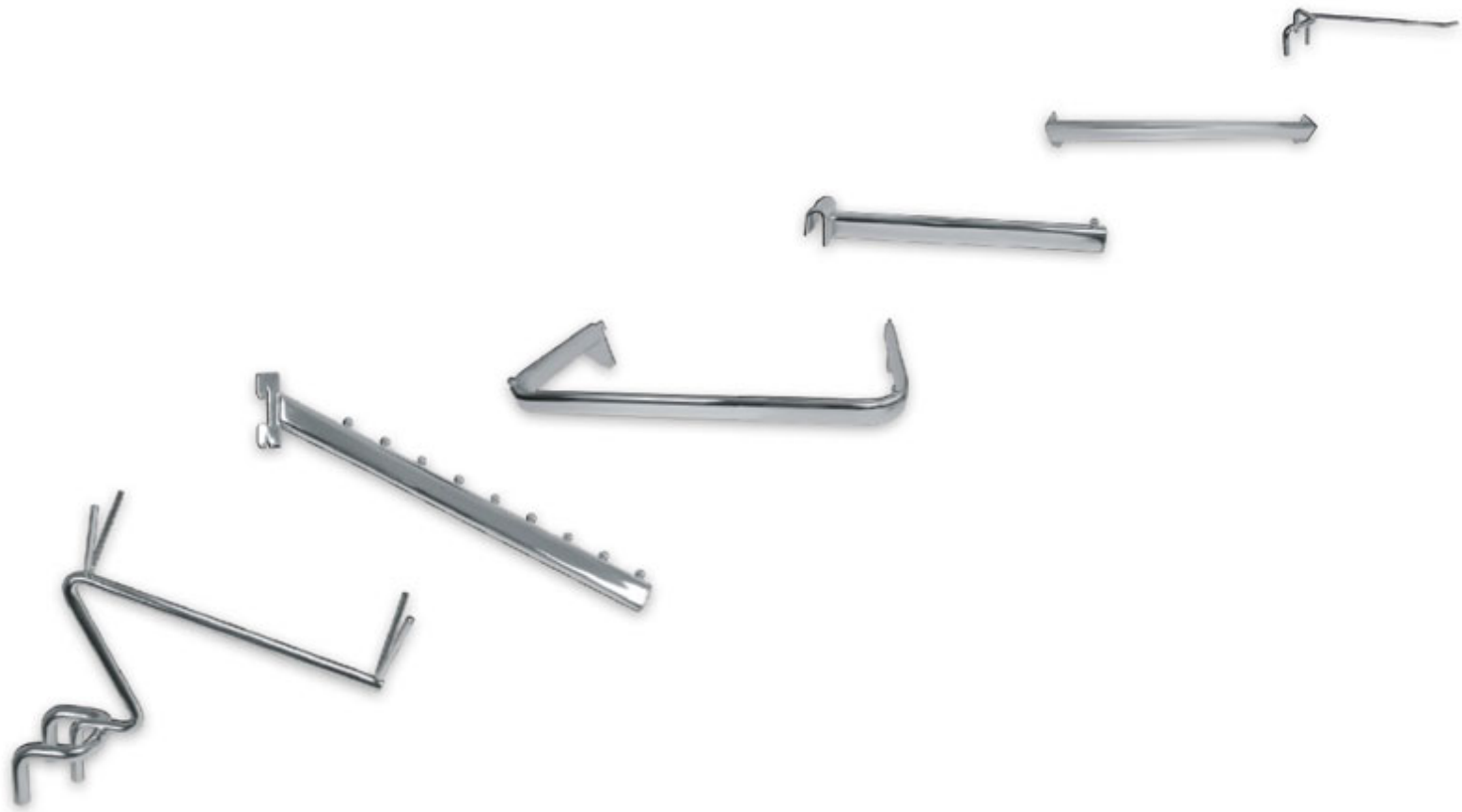



## Chromprogramm

Chromium-plated products  
Productos cromados  
Produits chromés

## Konfektionsrahmen aus Flachovalrohr Tiefe 250 mm und 350 mm

Side hanging frame for clothing, made of flat oval tube depth 250 and 350 mm

Barra expositora para ropa, tubo oval plano profundidad 250 y 350 mm

Cadre de confection, en tube ovale profondeur 250 et 350 mm



			mm	mm	mm		kg
8051100625			625	250	30x15	1	105,8
8051101000			1000	250	30x15	1	169,3
8051101250			1250	250	30x15	1	211,6
8061100625			625	350	30x15	1	105,8
8061101000			1000	350	30x15	1	169,3
8061101250			1250	350	30x15	1	211,6

Artikel nur auf Anfrage erhältlich / only on request / uniquement sur demande / solamente a pedido

## Trageschiene aus Flachovalrohr 30 x 15 mm

Support bar made of flat oval tube 30 x 15 mm

Barra de carga, tubo oval plano 30 x 15 mm

Barre de charge en tube ovale 30 x 15 mm



			mm		mm		kg
8051000625			625		30x15	1	81,0
8051001000			1000		30x15	1	129,0
8051001250			1250		30x15	1	161,0

Artikel nur auf Anfrage erhältlich / only on request / uniquement sur demande / solamente a pedido

## Einfachhaken für Trageschiene 30 x 15 mm

Holder for support bar 30 x 15 mm

Soporte para barra de carga 30 x 15 mm

Crochet simple pour barre de charge 30 x 15 mm



			mm	mm			kg
8051201505	15		5,0	150		1	5,9
8051202005	15		5,0	250		1	9,9
8051211505	15		7,0	150		1	8,3
8051212505	15		7,0	250		1	13,8
8051223005	15		9,0	300		1	17,6
8051224005	15		9,0	400		1	19,9

Artikel nur auf Anfrage erhältlich / only on request / uniquement sur demande / solamente a pedido

## Abhängearm gerade für Trageschiene 30 x 15 mm

Straight display arm for support bar 30 x 15 mm

Brazo recto para barra de carga 30 x 15 mm

Bras droit pour barre de charge 30 x 15 mm



				mm	mm		kg
8051253005	15			300	30x15	1	36,5
8051254005	15			400	30x15	1	48,7

Artikel nur auf Anfrage erhältlich / only on request / uniquement sur demande / solamente a pedido

## Abhängearm schräg, 30° geneigt mit Kugeln für Trageschiene 30 x 15 mm

Sloping front arm, 30° inclined, with balls, for support bar 30 x 15 mm  
 Brazo inclinado 30°, con botones, para barra de carga 30 x 15 mm  
 Bras incline 30°, avec billes, pour barre de charge 30 x 15 mm







8051244005	 15		 400		 30x15	 1	 47,1
------------	--	--	---	--	---	---	--

Artikel nur auf Anfrage erhältlich / only on request / uniquement sur demande / solamente a pedido



## Stufenabhängearm für Trageschiene 30 x 15 mm

Stepped arm for support bar 30 x 15 mm  
 Brazo escalera para barra de carga 30 x 15 mm  
 Bras à niveaux, pour barre de charge 30 x 15 mm







8051263505	 15		 350	 200	 30x15	 1	 58,5
------------	--	--	---	---	---	---	--

Artikel nur auf Anfrage erhältlich / only on request / uniquement sur demande / solamente a pedido



## Frontalabhängearm für Trageschiene 30 x 15 mm

Front arm for support bar 30 x 15 mm  
 Brazo recto para barra de carga 30 x 15 mm  
 Bras pour barre de charge 30 x 15 mm

8051304005	 15		 400	 200	 30x15	 1	 58,5
------------	--	--	---	---	---	---	--

Artikel nur auf Anfrage erhältlich / only on request / uniquement sur demande / solamente a pedido



## Präsenter für Ski-, Snowboard- und Bergschuhe für Trageschiene 30 x 15 mm

Holder for ski, snowboard and climbing boots, for support bar 30 x 15 mm  
 Soporte para ski, botas de snowboard y escalada, para barra de carga 30 x 15 mm  
 Support pour chaussures à ski/ snowboard, pour barre de charge 30 x 15 mm

3041620105	 15	 5,0	 200			 20	 32,7
------------	--	---	---	--	--	--	--

Mindestbestellmenge 500 Stück / minimum order quantity 500 pieces  
 Quantité minimale de commande: 500 pièces / cantidad mínima por pedido: 500 unidades



## Handschuhbügel teleskopierbar für Trageschiene 30 x 15 mm

Telescopic holder for the presentation of gloves, for support bar 30 x 15 mm

Soporte telescópico para guantes, para barra de carga 30 x 15 mm

Présentoir télescopique de gants, pour barre de charge 30 x 15 mm



Article-Nr.	Trageschiene	Ø	Abstand	Abstand	Abstand	Abstand	Abstand	Abstand	
8051313005	15	6,0/13,0	300-550					1	32,0

Artikel nur auf Anfrage erhältlich / only on request / uniquement sur demande / solamente a pedido

## Hut- und Mützenhalter mit 50 mm Schaumstoff für Trageschiene 30 x 15 mm

Holder for hats and caps with 50 mm foamed material, for support bar 30 x 15 mm

Soporte sombreros y gorras. 50 mm de espuma, para barra de carga 30 x 15 mm

Présentoir de chapeau et bonnet, avec 50 mm mousse, pour barre de charge 30 x 15 mm



Article-Nr.	Trageschiene	Ø	Abstand	Abstand	Abstand	Abstand	Abstand	Abstand	
8051342005	15	7,0	200		200			1	31,0

Artikel nur auf Anfrage erhältlich / only on request / uniquement sur demande / solamente a pedido

## Helmhalter für Trageschiene 30 x 15 mm

Helmet holder for support bar 30 x 15 mm

Soporte de cascos para barra de carga 30 x 15 mm

Présentoir de casque, pour barre de charge 30 x 15 mm





Article-Nr.	Trageschiene	Ø	Abstand	Abstand	Abstand	Abstand	Abstand	Abstand	
8051462505	15	8,0	360		250			1	40,0

Artikel nur auf Anfrage erhältlich / only on request / uniquement sur demande / solamente a pedido

Wir biegen Lösungen

## Trageschiene aus Vierkantrrohr 40 x 20 mm

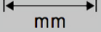
Support bar made of square tube 40 x 20 mm  
Barra de carga, tubo cuadrado 40 x 20 mm  
Barre de charge en tube carré 40 x 20 mm





						
	20		mm		1	kg
8052000625	20		625		1	105,0
8052001005	20		1000		1	145,0
8052001205	20		1250		1	181,0



Artikel nur auf Anfrage erhältlich / only on request / uniquement sur demande / solamente a pedido

## Einfachhaken für Trageschiene 40 x 20 mm

Holder for support bar 40 x 20 mm  
Soporte para barra de carga 40 x 20 mm  
Crochet simple pour barre de charge 40 x 20 mm







						
	20	mm	mm		1	kg
8052061005	20	8,0	100		1	7,3
8052062005	20	8,0	200		1	14,5
8052063005	20	8,0	300		1	21,8
8052064005	20	8,0	400		1	29,1



Artikel nur auf Anfrage erhältlich / only on request / uniquement sur demande / solamente a pedido

## Stufenabhängearm für Trageschiene 40 x 20 mm

Stepped arm for support bar 40 x 20 mm  
Brazo escalera para barra de carga 40 x 20 mm  
Bras à niveaux pour barre de charge 40 x 20 mm







							
	20		mm	mm	mm	1	kg
8052034505	20		450	250	30x15	1	84,8



Artikel nur auf Anfrage erhältlich / only on request / uniquement sur demande / solamente a pedido

## Frontalabhängearm für Trageschiene 40 x 20 mm

Front arm for support bar 40 x 20 mm  
Brazo recto para barra de carga 40 x 20 mm  
Bras pour barre de charge 40 x 20 mm

							
	20		mm	mm	mm	1	kg
8052044505	20		450	250	30x15	1	53,9



Artikel nur auf Anfrage erhältlich / only on request / uniquement sur demande / solamente a pedido





## Trennbügel für Trageschiene 40 x 20 mm

Separator for support bar 40 x 20 mm

Separador para barra de carga 40 x 20 mm

Séparateur pour barre de charge 40 x 20 mm







							
	mm			mm	mm		kg
8052054505	20			8,0	450	1	46,2

Artikel nur auf Anfrage erhältlich / only on request / uniquement sur demande / solamente a pedido

## Trageschiene aus Flachovalrohr 50 x 20 mm

Flat oval support bar 50 x 20 mm  
Barra de carga, tubo oval plano 50 x 20 mm  
Barre de charge en tube ovale 50 x 20 mm





			 mm			 kg
8050031005	20		1000		1	149,0
8050031205	20		1250		1	185,0

Artikel nur auf Anfrage erhältlich / only on request / uniquement sur demande / solamente a pedido



## Abhängeträger 30° geneigt mit 6 Haken für Trageschiene 20 mm

Sloping holder 30° inclined, with 6 hooks, for support bar 20 mm  
Soporte inclinado 30°, con 6 ganchos, para barra de carga 20 mm  
Bras incliné 30°, avec 6 crochets, pour barre de charge 20 mm





			 mm	 mm		 kg
8070294705	20		8,0	470	1	66,0

Artikel nur auf Anfrage erhältlich / only on request / uniquement sur demande / solamente a pedido



## Frontalwareträger 30° geneigt mit 10 Kugeln für Trageschiene 20 mm

Sloping holder 30° inclined, with 10 balls for support bar 20 mm  
Soporte inclinado 30°, con 10 botones, para barra de carga 20 mm  
Bras incliné 30°, avec 10 billes, pour barre de charge 20 mm





			 mm	 mm		 kg
8069334005	20		10,0	415	1	51,0

Artikel nur auf Anfrage erhältlich / only on request / uniquement sur demande / solamente a pedido



## Halter für 10 Tennisschläger 30° geneigt, Unterteiler ummantelt für Trageschiene 20 mm

Holder for 10 tennis rackets, 30° inclined, pins coated for support bar 20 mm  
Soporte para 10 raquetas de tenis, inclinado 30°, con clavijas para barra de 20 mm  
Support incliné 30° pour 10 raquettes de tennis, broches enrobées pour barre de charge 20 mm

			 mm	 mm		 kg
8065644305	20		10,0	430	1	102,0

Artikel nur auf Anfrage erhältlich / only on request / uniquement sur demande / solamente a pedido







## Bügeleisenhalter für Trageschiene 20 mm

Iron holder for support bar 20 mm

Soporte de hierro para barra de carga de 20 mm

Présentoir de fer à repasser, pour barre de charge 20 mm



8020000105	 20		 8,0	 210	 1	 28,7
------------	--	--	---	---	---	--

Artikel nur auf Anfrage erhältlich / only on request / uniquement sur demande / solamente a pedido





## Haartrockenhalter für Trageschiene 20 mm

Hair-dryer holder for support bar 20 mm

Soporte secador para barra de carga 20 mm

Présentoir de sèche-cheveux, pour barre de charge 20 mm



8030000105	 20		 8,0	 100	 1	 30,6
------------	--	--	---	---	---	--

Artikel nur auf Anfrage erhältlich / only on request / uniquement sur demande / solamente a pedido





## Lockenstabhalter für Trageschiene 20 mm

Holder for curling tongs, for support bar 20 mm

Soporte tenacillas, para barra de carga de 20 mm

Présentoir de fer à friser, pour barre de charge 20 mm



8040000105	 20	 8,0	 200		 1	 29,7
------------	--	---	---	--	---	--

Artikel nur auf Anfrage erhältlich / only on request / uniquement sur demande / solamente a pedido





## Wäschetasche rechts/links für Trageschiene 20 mm

Holder for clothes bags, right/left, for support bar 20 mm

Soporte bolsas de tela, a la derecha/izquierda, para barra de carga de 20 mm

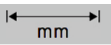
Support pour sacs à linge, à droite/gauche, pour barre de charge 20 mm

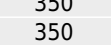

8077484505	 20	 350	 450		 1	 190,0
8077494505	 20	 350	 450		 1	 190,0

Artikel nur auf Anfrage erhältlich / only on request / uniquement sur demande / solamente a pedido



## Abhängearm schräg, 30° geneigt mit Kugel für Säule 2reihig

Sloping front arm, 30° inclined, with balls, for two-rowed column

Brazo inclinado 30°, con botones, para columna doble ranura

Bras incliné 30°, avec billes, pour colonne à deux rangées

8051274005			400		30x15	1	47,1
Artikel nur auf Anfrage erhältlich / only on request / uniquement sur demande / solamente a pedido							



## Schrägabhängearm für Säule 2reihig

Sloping front arm for two-rowed column

Brazo inclinado para columna doble ranura

Bras incliné pour colonne à deux rangées

8052084505			450	300	30x15	1	80,0
Artikel nur auf Anfrage erhältlich / only on request / uniquement sur demande / solamente a pedido							

